

**CERTIFICATE AS TO
AMENDED AND RESTATED DECLARATION OF CONDOMINIUM
OF
SUNFISH BAY CONDOMINIUM II
CLEARWATER, PINELLAS COUNTY, FLORIDA**

NOTICE IS HEREBY GIVEN that at a duly called meeting of the members on January 24, 2019, which was recessed and reconvened on February 9, 2019, called for the purpose of voting on the proposed Amended and Restated Declaration of Condominium of Sunfish Bay Condominium II, which was presented to the unit owners for vote with new wording being underlined and strike-throughs of any language being removed, the original Declaration of Condominium of Sunfish Bay Condominium II, being recorded in O.R. Book 4248, Page 963 et seq. of the Public Records of Pinellas County, Florida, was duly adopted by an affirmative vote of at least seventy-five percent (75%) of the total units of the Condominium. The Declaration is amended and restated in its entirety to read as reflected on the attached Amended and Restated Declaration of Condominium of Sunfish Bay Condominium II, Clearwater, Pinellas County, Florida, which is incorporated in its entirety herein by this reference.

IN WITNESS WHEREOF, SUNFISH BAY CONDOMINIUM ASSOCIATION, INC. has caused this Certificate to be executed in accordance with the authority hereinabove expressed this 5 day of MARCH, 2019.

Diane Weller
Diane Weller, Chairman
Amendment Committee

David Butler
David Butler, Co-Chairman
Amendment Committee

**SUNFISH BAY CONDOMINIUM
ASSOCIATION, INC.**

(Corporate Seal)

By: Ann Ruppert
_____, President

ATTEST:

Pauline Roman, Secretary

STATE OF FLORIDA
COUNTY OF PINELLAS

The foregoing instrument was acknowledged before me this 5 day of MARCH, 2019, by ANN RUPPERT, as President, and PAULINE ROMAN, as Secretary of SUNFISH BAY CONDOMINIUM ASSOCIATION, INC., a Florida not-for-profit corporation, on behalf of the corporation. They took an oath, and are personally known to me or have produced FLORIDA DRIVER LICENSE and PENNSYLVANIA DL as identification to be the President and Secretary of the corporation executing the foregoing instrument, and they acknowledged executing the same voluntarily under the authority duly vested in them by said corporation. If no type of identification is indicated, the above-named persons are personally known to me.

My Commission Expires: 05/24/2020

Scott Toweson
Notary Public
State of Florida at Large



My Commission Expires 5/24/2020
Commission No. FF 967755

**AMENDED AND RESTATED DECLARATION OF CONDOMINIUM
OF
SUNFISH BAY CONDOMINIUM II
CLEARWATER, PINELLAS COUNTY, FLORIDA**

This is an AMENDED AND RESTATED DECLARATION OF CONDOMINIUM OF SUNFISH BAY CONDOMINIUM II made this 24th day of January, 2019, by SUNFISH BAY CONDOMINIUM ASSOCIATION, INC., the Condominium Association responsible for the operation of the Condominium, by the procedures and vote called for in the Declaration and Chapter 718 of the Florida Statutes, as same is in effect at the time of recording this Amended and Restated Declaration of Condominium.

WHEREAS, the Unit Owners are the collective owners, in fee simple, of certain real property, described herein and which became a Condominium by virtue of that certain Declaration recorded January 7, 1975 at Official Records Book 4248, Page 963 et seq. of the Public Records of Pinellas County, Florida and revisions thereof, and in accordance with the provisions for amendment thereof, the Association hereby makes the following Amended and Restated Declaration of Condominium.

I
Purpose

1.1 Purpose. The purpose of this Amended and Restated Declaration is to continue to submit the lands described in the instrument, and improvements constructed and to be constructed thereon, to the condominium form of ownership and use in the manner provided by law, including Chapter 718, Florida Statutes, as same may be amended from time to time, hereinafter called the "Condominium Act."

II
Identification

2.1 Name and Address. The name by which this Condominium is to be identified is Sunfish Bay Condominium II, a Condominium, also known as Building C and Building D, and its address is 1111 Bayshore Boulevard, Clearwater, Pinellas County, Florida.

2.2 Lands. The lands which are included within this Condominium and are here submitted to condominium ownership in accordance with the Condominium Act are described in Exhibit "A" attached hereto. IT IS EXPRESSLY ACKNOWLEDGED THAT THE CONDOMINIUM PLATS ARE NOT "AS BUILT" AND MAY NOT REFLECT ALL DEVELOPER MADE IMPROVEMENTS OR CURRENT ASSIGNMENT OF GARAGES OR CARPORTS.

III Definitions

The terms used in this Declaration and in its exhibits shall have the meaning stated in the Condominium Act except as otherwise provided herein and except as the context otherwise requires.

3.1 Developer. Tibma Bros. Development & Construction Co, its successors, designees and assigns.

3.2 Association or Condominium Association. Association means Sunfish Bay Condominium Association Inc., a nonprofit Florida corporation and its successors, which shall have the responsibilities hereinafter described. The Condominium Association operates and manages, in conjunction with this Condominium, Sunfish Bay Condominium I, Sunfish Bay Condominium III, Sunfish Bay Condominium IV, and Sunfish Bay Condominium V. The Common Elements of this Condominium are not a part of and are not merged with the Common Elements of the additional Condominiums governed by the Association, and each Condominium is a separate Condominium under the laws of the State of Florida; however, there may be common control, policy, procedure, management and purpose among all such Condominiums and the owners of Units and Condominium Parcels in same.

3.3 Condominium Act. Chapter 718, Florida Statutes, as same may be amended from time to time.

3.4 Condominium. All of the Condominium Property and improvements thereon and, in addition, that form of ownership of property under which units are subject to separate and exclusive ownership and there is appurtenant to each Unit as a part thereof, Common Elements, as hereinafter described.

3.5 Condominium Property. Means the lands, leaseholds and personal property (such as chairs and tables at the pool, if any) that are subjected to condominium ownership, whether or not contiguous, and all improvements thereon and all easements and rights appurtenant thereto intended for use in connection with the Condominium.

3.6 Condominium Unit or Unit. A part of the Condominium Property which is to be subject to exclusive ownership.

3.7 Condominium Parcel. A Unit together with the undivided share in the Common Surplus and the Common Elements and Limited Common Elements which are appurtenant to the Unit.

3.8 Unit Owner or Owner. The record owner of the Condominium Parcel, who is either the Developer or one who acquires his or her ownership interest from the Developer or subsequent to such acquisition from the Developer.

3.9 Common Area. Means 19/66ths of all that land together with buildings and appurtenances and all other improvements, facilities, equipment, betterments and furniture (from time to time, replaced or repaired) located thereon conveyed to the Association by TIBMA BROS. DEVELOPMENT & CONSTRUCTION CO. by deed dated December 30, 1977 and recorded in Official Records Book 4640, Page 1444, of the Public Records of Pinellas County, Florida. Said 19/66ths is an undivided interest held by the Association for the benefit of the Unit Owners of this Condominium. This area includes, but is not limited to, the docks, tennis court, and swimming pool.

3.10 Common Expenses. The expenses for which Unit Owners are liable, except as may otherwise be provided herein, including expenses of administration, expenses of maintenance, operation, repair and replacement of the Condominium and Common Elements and common area and of any other properties to be maintained by the Association as provided herein including portions of the Units, any other expenses to be incurred by the Association, or to perform and fulfill its powers, duties and responsibilities, as provided herein and in the Articles of Incorporation and By-Laws, any valid charge against the Condominium Property as a whole, and expenses declared Common Expenses by this Declaration or by the By-Laws of the Association (hereinafter referred to as "The By-Laws"). There are common expenses of this Condominium and there are also common expenses of the Sunfish Bay Condominiums Development as a whole which make up a part of the common expenses of this Condominium.

3.11 Common Surplus. Means the excess of all receipts of the Association collected on behalf of the Condominium including, but not limited to, assessments, rents, profits, and revenues on account of the Common Elements - - over the Common Expenses.

3.12 Common Elements. The portions of the Condominium Property not included in the individual Units, but does not include the Common Area. There shall be, and are, as a part of the Common Elements to be maintained by Common Expenses, easements, including easements to Developer and to any other party charged with the responsibility for construction, repair, replacement, maintenance and the like of any Common Elements or other property under this Declaration or documents incident thereto, through the Units, for conduits, pipes, plumbing, wiring and other facilities for the furnishing of utility service to more than one Unit, and Common Elements, together with easements of support in every portion of a Unit, which contributes to the support of the improvements. Each Unit Owner in this Condominium owns 1/19th of an undivided interest in the Common Elements of this Condominium.

3.13 Limited Common Elements. The portion of the Common Elements limited to the exclusive use and enjoyment of the Owner of an individual Unit.

3.14 Assessments. A share of the funds required for the payment of Common Expenses which from time to time is assessed against the Unit Owner.

3.15 Sunfish Bay Condominiums Development. The overall community made up of Sunfish Bay Condominium I, Sunfish Bay Condominium II, Sunfish Bay Condominium III, Sunfish Bay Condominium IV, and Sunfish Bay Condominium V.

3.16 Utility Service. Utility Services as used in the Condominium Act and as construed with reference to this Condominium and as used in this Declaration and the By-Laws, may include, but not be limited to electric power, gas, hot and cold water, garbage and sewage disposal, and television and internet apparatus.

3.17 Singular Plural and Gender. Whenever the context so permits, the use of the plural shall include the singular, the singular the plural, and the use of any gender shall include all genders.

IV Development Plan

4.1 Development Plan. The Condominium is described as follows:

4.2 Survey and Plot Plan. A survey of the land subject to this Condominium, including a plot plan showing the location of the Condominium Parcels and Units, the Common Elements and their relative locations and dimensions is attached hereto and made a part hereof as Exhibit "A". IT IS EXPRESSLY ACKNOWLEDGED THAT THE CONDOMINIUM PLATS ARE NOT "AS BUILT" AND MAY NOT REFLECT ALL DEVELOPER MADE IMPROVEMENTS OR CURRENT ASSIGNMENT OF GARAGES OR CARPORTS.

4.3 Improvements. Improvements upon the land include, but are not limited to, one (1) Condominium Building of 19 Units.

4.4 Unit Boundaries. Each Unit shall include that part of the building containing the Unit that lies within the following boundaries:

(a) Upper and Lower Boundaries. The upper and lower boundaries of a Unit shall be the following boundaries extended to an intersection with the perimetrical boundaries:

1. Upper Boundary. The horizontal plane of the undecorated and unfinished lower surface of the ceiling.

2. Lower Boundary. The horizontal plane of the undecorated and unfinished uppermost surface of the floor.

(b) Perimetrical Boundaries. The perimetrical boundaries of the Unit shall be the vertical planes of the undecorated finished interior of the walls bounding the Unit extended to an intersection with each other and with the upper and lower boundaries. The Unit area shall not include the undecorated and unfinished surface of the perimeter walls, floors and ceilings surrounding the Unit and the pipes, wires, conduits, or other public utility lines running through the Unit area which are utilized for or serve more than one Unit or a Unit other than the Unit in which they are contained, the aforementioned not included items being included in the definition of Common Elements.

4.5 Easements.

(a) Easements are reserved to the Association through, over, on and under the Common Elements, including Limited Common Elements (whether or not such easements are shown on the exhibits attached hereto, any amendments hereto, or on any documents incident to or a part of sales of units) as may be from time to time established and deemed proper by the Association for utility services, drainage and other purposes in order to serve the Condominium or Sunfish Bay Condominiums Development or any Condominium therein, adequately, so long as such easements do not unreasonably interfere with the use of units and with ingress and egress thereto and therefrom. The Association may establish such easements in such manner as the Association deems proper, including by recordation in the Public Records of Pinellas County, Florida of documents describing same, it being understood that the Association will, to the extent reasonably and financially feasible for the Association, establish any such easements on or near boundary lines of Common Elements and Limited Common Elements and that such right to establish such easements shall exist only to the extent provided in the Condominium Act.

(b) Non-exclusive easements of way for ingress and egress were and are hereby granted by Developer to the Condominium, and Unit Owners therein, over that certain roadway which provides this Condominium with access from and to Bayshore Boulevard and over property to and from the waterfront immediately adjacent to the Units, it being understood that said roadway and property is not a part of the Condominium Property.

(c) There is specifically reserved to Developer, or its assigns, the exclusive right to install and maintain cable and antennae and any other facilities for cable television (CATV) on the Common Elements and Limited Common Elements for service to the Units in this Condominium and other adjacent and neighboring Condominiums as otherwise referred to herein, which service, if provided, shall be provided at the approximate level of rates generally prevailing for same in Pinellas County, Florida. Such right includes the reservation to the Association of such easements on, under, over and through the Condominium Property as necessary or appropriate for installation of such facilities and ingress to and egress from same for installation, maintenance, repair and replacement, it being understood that such easements will be, to the extent reasonably and financially feasible, established on or near boundary lines of Common Elements and Limited Common Elements.

4.6 Common Expenses.

(a) "Expense of this Condominium" means the costs of administration and operation of the Association for the direct benefit of the Unit Owners in this Condominium, expenses and costs of maintenance, repair, replacements or improvements of the "Common Elements" and of the portions of Units of this Condominium to be maintained by the Association. The following is a non-exhaustive list of examples of Expenses of this Condominium:

- (1) Building structure (e.g. outside walls and foundation);
- (2) Building roof and garage roofs;
- (3) Exterior wood maintenance and replacement;

- (4) Building and garage stucco;
- (5) Building and garage paint;
- (6) Flood insurance;
- (7) Flat roofs on third and second level master bedrooms, if applicable;
- (8) Plumbing leaks in shared lines and pipes or conduits that service more than just a single unit; and
- (9) Exterior chimney maintenance and repair.

(b) “Expense Declared to be Common Expense” means expenses declared Common Expenses by provisions of this Declaration or by the By-Laws, including, but not limited to, maintenance contract payments.

(c) “Expense of Common Area” or “Master Expense of the Sunfish Bay Condominiums Development” means 19/66ths of the costs of administration and operation, maintenance, repair, replacements or improvements to the “Common Area”. The expenses of the Common Area shall include, but not be limited to, all sidewalks throughout the Sunfish Bay Condominiums Development real property and those located upon the individual Condominium and its Common Elements to the extent they may be used by all owners in this Condominium and the other Condominiums in the Sunfish Bay Condominiums Development; the swimming pool; tennis courts; North dock; South dock; Watercraft storage racks; lawn care and shrub maintenance; Mangrove trimming; Palm and tree trimming; Property and Hazard insurance on all buildings throughout the overall Sunfish Bay development; and the garbage dumpster enclosure area. The following is a non-exhaustive list of examples of Master Expenses of the Sunfish Bay Condominiums Development:

- (1) walkways except where same have been modified by an Owner unless the Association has expressly assumed the obligation for maintenance of same;
- (2) entrance signage and other signage throughout the Sunfish Bay Condominiums Development;
- (3) roadways and parking areas;
- (4) North and South docks;
- (5) street lighting and lampposts and other electrical fixtures that are not on the Building(s) of the individual Condominiums;
- (6) Building sewage treatment;
- (7) plumbing leaks exterior to the Building(s) of the individual Condominiums;
- (8) all landscaping including, but not limited to, palmetto bushes and lawn mowing except where same has been added by individual owner unless Association has expressly assumed the obligation for maintenance of same;
- (9) Palm and tree trimming;
- (10) irrigation system;
- (11) mangroves;
- (12) termite treatments for subterranean termites;
- (13) swimming pool and pool enclosure and electrical components;
- (14) tennis court;

- (15) watercraft storage racks;
- (16) garbage dumpster enclosure;
- (17) property/hazard insurance and general liability; and
- (18) property management administrative expenses.

(d) Common Expenses, which are also otherwise herein defined, shall include the Condominium's proportionate share of the cost and expense of maintaining, servicing, repairing and replacing all streets, sidewalks, street lighting and lamp posts and utility installations of all kinds, drainage facilities and other structures, facilities, improvements, including boundary walls, and areas of any kind located on any easements of or through the Condominium and on any part of the Common Elements and Limited Common Elements of the Condominium and on other property, such as the Common Area, or Condominiums in the vicinity for purposes to serve this Condominium, as well as other Condominiums within the Sunfish Bay Condominiums Development and the recreational area now owned by the Association for the use and benefit of the Unit Owners or as otherwise available for use by such Unit Owners, such Common Expenses to also include taxes assessed against such property. The proportionate share to be borne by this Condominium of such Common Expenses for purposes which serve this Condominium and other Condominiums shall be 19/66ths.

(e) Such Common Expenses shall include the cost and expense of repairing and maintaining in good condition the entrance and service roadways which provide this Condominium and other Condominiums within the Sunfish Bay Condominiums Development with access from and to Bayshore Boulevard and other streets and roadways which directly or indirectly serve this Condominium and other Condominiums within the Sunfish Bay Condominiums Development, whether or not any such streets and roadways are a part of the property of this or such other Condominiums, and the land adjacent to said roadways and not within this Condominium or any other Condominiums, it being understood that such cost and expense shall be paid by the Association and that such Common Expenses shall be a Master Expense of the Sunfish Bay Condominiums Development and shall also include taxes assessed against said roadways and said land adjacent thereto.

(f) Such Common Expenses shall also include the maintenance, repair, replacement and improvement of the Common Area which each Unit Owner shall have the right to use, which shall include but not be limited to the swimming pool; tennis courts; North dock; South dock; Watercraft storage racks; and the garbage dumpster enclosure area. Any taxes assessed against same, shall be an Expense of Common Area and shall be paid by the Association as a Master Expense of the Sunfish Bay Condominiums Development. The right to use Common Areas shall be subject to the right of the Association to suspend use rights where permitted by the Condominium Act.

(g) Expenses of Individual Unit Owner. The following is a non-exhaustive list of those items for which the individual Unit Owner is responsible at his or her sole cost and expense:

- (1) screens;
- (2) windows and window casings and associated hardware and caulking and/or sealing of same;

- (3) skylights and the seal around same;
- (4) shutters and related hardware;
- (5) entry door and all other doors, door framing and associated hardware, including, but not limited to, sliding glass doors and their tracks;
- (6) second and third level deck surfaces off the master bedrooms, if applicable;
- (7) awnings and their associated hardware;
- (8) HVAC system which shall include, but not be limited to, air compressor and air handler and all ductwork whether located inside or outside of the boundaries of the Unit;
- (9) plumbing fixtures such as sinks and toilets and their seals and plumbing lines up to their connection with the main line (i.e. the line servicing more than just a single unit);
- (10) water softeners;
- (11) patios and decks;
- (12) owner modified stairways;
- (13) owner installed exterior improvements unless expressly assumed by the Association by written approval to be the maintenance obligation of the Association;
- (14) private courtyard areas and gardens;
- (15) gutters added after initial construction;
- (16) floor coverings;
- (17) interior paint;
- (18) baseboards and crown molding, if any;
- (19) wall and ceiling texture;
- (20) interior electrical wiring and electrical fixtures;
- (21) exterior electrical fixtures added after initial construction;
- (22) all appliances and water heaters;
- (23) garage doors (both drive through and walk through);
- (24) interior chimney maintenance and repair and keeping same clear;
- (25) painting of exterior stucco within any screened enclosure; and
- (26) day-to-day cleaning of entrance to unit and surrounding area.

V

Units

5.1 Units. The Units of the Condominium are more particularly described, and the rights of their owners established, as hereinafter provided.

5.2 Unit Definition. There are 19 units in the condominium, numbered C-1, 3, 4, 5, 6, 7, 8, 9, 10, 11, 12, D-1, 2, 3, 4, 5, 6, 7, 8. Each unit is located on the plot plan attached hereto as Exhibit "A" and incorporated herein and is identified by the number designated thereon. In the event of any discrepancy between the actual location of any Unit and the location of the Unit on Exhibit "A", the actual location will take precedence and govern. IT IS EXPRESSLY ACKNOWLEDGED THAT THE CONDOMINIUM PLATS ARE NOT "AS BUILT" AND MAY NOT REFLECT ALL DEVELOPER MADE IMPROVEMENTS OR CURRENT ASSIGNMENT OF GARAGES OR CARPORTS.

5.3 Appurtenances to Units. The owner of each Unit shall own a share and certain interests in the Condominium Property, which share and interests are appurtenant to the Unit, including the following:

(a) Common Elements and Surplus: The undivided share in the Common Elements and in the common surplus which are appurtenant are as follows: An Undivided one nineteenth (1/19) share to each unit. The Common Elements shall include any land, any streets, any sidewalks and planting areas, and all other parts of the Condominium outside of the Units.

(b) Limited Common Elements. The exclusive use of Limited Common Elements as follows:

1. The portion of the Common Elements limited to the exclusive use and enjoyment of the owner of a Unit, is identified in Exhibit "A" by a number corresponding to the number of the Unit. In the event of disagreement as to the boundaries of any Limited Common Elements under the foregoing provisions, the Board of Directors shall have the right to designate, such boundaries within those provisions, and such designation shall be final and binding upon affected Unit Owners.

2. The Limited Common Elements include patios and balconies that were part of original construction. Limited Common Elements further include garages, carports, stairways and sidewalks that service only a single unit.

3. Garage(s) or carport(s) serving solely a particular owner's Unit, as same are identified on Exhibit "A" by a number corresponding to the number of the Unit, provided that in the case of portions of driveways serving two Units, as may be shown on Exhibit "A", the exclusive use of such portions shall be shared equally by each such Unit Owner and shall be in such manner so as not to interfere unreasonably with the other Unit Owner's use thereof. It is acknowledged that there have been past transfers of garages and/or carports and the Board of Directors shall not be responsible for reversing any past transfers. There shall be no further transfer of a garage or carport separate and apart from the transfer of the Unit; except that a garage or carport within the common elements of this Condominium may be transferred to a Unit Owner having title to a Unit within this Condominium with the express written consent of the Association and by an assignment which shall be recorded in the Public Records of Pinellas County, Florida by the Unit Owner being transferred the right to use the garage or carport at his or her sole expense. Garages or carports shall not be leased to non-residents.

4. Any space designated by Board resolution which shall be executed by the Board President with the formalities of a deed and recorded in the public records of Pinellas County, Florida to be a Limited Common Element so long as each and every Unit within the Condominium is afforded the same space and use rights. This designated space shall be subject to reasonable rules and regulations as to use and appearance.

5. To the extent that any modifications are made to a Limited Common Element area which differ from the original construction by the Developer, the individual Unit Owner shall be responsible for the maintenance, repair or replacement of same at

his or her sole cost and expense unless the obligation for same is expressly assumed by the Association.

(c) Easements. Easements for the benefit of the Unit.

(d) Association Membership. The membership of each Unit Owner in the Association and the interests of each Unit Owner in the funds and assets held by the Association and the voting rights as further set forth in the condominium documents.

VI

Maintenance, Alteration and Improvement

6.1 Maintenance Alteration and Improvement. The responsibility for the maintenance of the Condominium Property and restrictions upon the alterations and improvement thereof, shall include the following:

6.2 By the Association. The Association shall maintain in good condition and repair and service and replace at the Association's expense, which shall be a Common Expense of this Condominium:

(a) All Common Elements and Limited Common Elements, except where the maintenance, repair or replacement of a Common Element has been specified to be a Master Expense of the Sunfish Bay Condominiums Development or a Limited Common Element is expressly made the obligation of the individual Unit Owner having the use thereof. The painting of doors, shutters, window trim and any other exterior surfaces shall be the exclusive right and responsibility of the Association and the expense shall be a Common Expense of this Condominium the same as such expense for the painting of exterior wall surfaces.

(b) All roofs and exterior surfaces of Units and the structures of which Units are a part, including exterior surfaces of walls, which shall specifically include painting of same, the color to be the same as the original color unless a change in color is approved by the Association as set forth in Section 6.7 of this Declaration.

6.3 By the Unit Owner.

(a) To keep and maintain the portions of his or her Unit in good condition and repair and state of cleanliness at his or her sole expense. These items shall include, but not be limited to, screens; windows and window casings and associated hardware; shutters and related hardware; doors and door framing and associated hardware; skylights and related hardware; awnings and their associated hardware; HVAC system which shall include, but not be limited to, air compressor and air handler and all ductwork whether located inside or outside of the boundaries of the Unit; plumbing fixtures such as sinks and toilets and the seals around same; water softeners; patios; decks; or other owner installed exterior improvements unless expressly assumed by the Association by written approval to be the maintenance obligation of the Association; private courtyard areas; gutters added after initial construction; floor coverings; paint; baseboards; and wall and ceiling texture; interior electrical wiring and electrical fixtures;

exterior electrical fixtures added after initial construction; and all appliances and water heaters. Same shall be accomplished without delay and, to the greatest extent possible, without disturbing other Unit Owners. In the event the Unit Owner shall fail to maintain his or her Unit or any portion thereof or any portion of the property otherwise made the responsibility of the individual Unit Owner, after reasonable notice of the Association of the need to do so, the Association shall have the right but not the obligation to maintain, repair and/or replace such portions, in which event the expense of same shall be specifically assessed against and borne by the particular Unit Owner and unit in the same manner as provided for other assessments including through the recording of a Claim of Lien and foreclosure of same.

(b) Not to paint or otherwise decorate or change the exterior appearance or the structure of any portion of a unit or the exterior of a unit or the Common Elements or Limited Common Elements or impair any easement without the express written approval of the Board of Directors. In particular, not to, without the approval of the Board of Directors, add or remove screening or other enclosure of a carport and/or garage and/or balconies or patios, affix or remove shutters of any kind, remove, alter or construct fences or walls of any kind and remove or alter any portion of, or fixture or appurtenance on, a building or do any act which will impair the structural soundness of the building. In the event a Unit includes an adjacent patio, Unit Owner shall not screen in or otherwise enclose said patio unless and until said Unit Owner has obtained the written consent of all other Unit Owners within this Condominium and the written consent of the Board of Directors. Unit Owner shall be solely responsible for obtaining any and all necessary permits and for compliance with applicable buildings codes and ordinances and corrections of any deficiencies or damages caused by said screening or enclosure.

(c) To promptly report to the Association any defect or need for repairs or maintenance for which the Association or any Unit Owner is responsible.

(d) The Association's determination of the necessity, under the foregoing provisions, to maintain, repair, service or replace any property, including portions of Units, for which the Association has such responsibility shall be binding upon Unit Owners, provided that the Association may delegate such right of determination to the Management Contractor.

(e) The Unit Owner may change the front door of the Condominium Unit with approval of the Board of Directors. The Board of Directors shall adopt a schedule of acceptable colors/stains and no vote of the owners shall be necessary to authorize changes to the doors.

(f) Unit Owners may, with the approval of the Board of Directors, install a deck at the rear of the first floor units. Upon installation, the deck shall be a Limited Common Element. The Board shall adopt specifications showing the acceptable size, location, material and color of such decks. The Unit Owner shall be responsible for all maintenance of any deck installed. The deck must be finished in accordance with specifications adopted or amended by the Board of Directors from time to time.

6.4 Covenant Against Partition. In order to preserve the Condominium, the Common Elements and Limited Common Elements (except as otherwise specifically provided herein) shall remain undivided, and no Unit Owner, or any other person, shall bring any action for

partition or division of the whole, or any part thereof, of the Common Elements or Limited Common Elements so long as any Unit exists in useful condition upon the land.

6.5 Non-exclusive Possession. Each Unit Owner and the Association may use Common Elements for the purposes for which they are intended subject only to the restrictions contained herein and to such other reasonable Rules and Regulations established by the Association, which shall not be inconsistent herewith, and no such use shall hinder or encroach upon the lawful rights of other Unit Owners.

6.6 Maintenance and Operation of Common Elements. The maintenance and operation of the Common Elements and Limited Common Elements shall be the responsibility of the Association and a Common Expense, except where expressly stated otherwise.

6.7 Improvements on Common Elements. No material alteration or substantial addition to or subtraction from improvements in and on the Common Elements may be made, except upon the affirmative vote of at least seventy-five (75%) percent of the members of the Association (meaning the Unit Owners within this Condominium together with Unit Owners of all other Condominiums in the Sunfish Bay Condominiums Development) present and voting at a duly noticed meeting of the members where at least a majority of the members are represented. The quorum shall be a majority of the membership based upon the total number of units throughout Condominiums I, II, III, IV and V (i.e. 66 units total). Notwithstanding this provision, the Board of Directors by at least a seventy-five (75%) percent vote of the directors in favor of the requested alteration or modification, may authorize a change or alteration to Limited Common Elements and no vote of the Unit Owners or members shall be necessary.

6.8 Alterations or Modifications to Common Area. The Board of Directors may authorize any alteration or modification to the Common Area that would cost less than Thirty Thousand Dollars (\$30,000.00) to accomplish in the aggregate and no vote of the Unit Owners or members shall be necessary. This shall apply to the total cost of the alteration or modification and the alteration or modification may not be completed in phases or broken down into various components in order to comply with this monetary threshold and avoid taking a vote of the members of the Association. By way of example, if it would cost \$60,000.00 to change the style of pool decking, this could not be broken down into phases with each phase being less than \$30,000.00, the overall cost of the alteration or modification from start to finish is what will control. If it would cost \$45,000.00 to convert the tennis court to additional parking, this could not be broken out into \$20,000.00 to demolish the existing tennis court and \$25,000.00 to lay the new pavement. To the extent the cost would exceed Thirty Thousand Dollars (\$30,000.00), then an affirmative vote of at least seventy-five (75%) percent of the members of the Association (meaning the Unit Owners within this Condominium together with Unit Owners of all other Condominiums in the Sunfish Bay Condominiums Development) present and voting at a duly noticed meeting of the members of the Association at which a quorum is present shall be required. The quorum shall be a majority of the membership based upon the total number of units throughout Condominiums I, II, III, IV and V (i.e. 66 units total).

VII

Common Expenses and Assessments

7.1 Liability for Common Expenses. Each Unit Owner shall be liable for a one/nineteenth (1/19) share of the Common Expenses and shall share in any common surplus, such shares being the same as the undivided share in the Common Elements appurtenant to the Unit owned by him or her. Common Expenses shall be those designated as such in this Declaration and in the Articles of Incorporation and By-Laws of the Association. Each Unit Owner shall also be responsible for their respective portion of this Condominiums 19/66ths of the expenses of the Common Area and overall administration expenses of the Association that cannot be attributed to a specific Condominium.

7.2 Liability. A Unit Owner, regardless how title is acquired, shall be liable to the Association for assessments for Common Expenses and expenses of the Common Area and other purposes due hereunder and as provided in the By-Laws while he or she is owner of a Unit. In the event of a conveyance of a Unit (not including a conveyance pursuant to tax deed sale or a conveyance to an institutional first mortgagee in lieu of foreclosure) the grantee shall be liable severally and jointly with the grantor for all unpaid assessments against the grantor for his or her share of the Common Expenses owed for the period up to the time of such conveyance. If an institutional first mortgagee obtains title to a Unit as the result of foreclosure of a first mortgage thereon or by a voluntary conveyance in lieu of foreclosure, such acquirer of title, its successors, grantees, and assigns shall be liable for the assessments owing for the period up to the time of acquisition of title by such mortgagee to the extent provided in Section 718.116 of the Florida Statutes, as same may be amended from time to time. The first mortgagee shall be liable for any and all assessments coming due while the first mortgagee is the record owner. A third party at the foreclosure sale of a first mortgagee shall be liable for any and all assessments coming due prior to a Certificate of Title being issued which remain outstanding at the time he or she takes title to the unit.

7.3 Payment of Assessments. All assessments and installments on assessments shall be payable to the Association on or before ten (10) days after the due date provided for in the By-Laws, and said sums not so paid shall bear interest at the rate of eighteen percent (18%) per annum from and after the due date until paid. The Association shall have the authority to charge a late fee in an amount as may be set or changed by the Board of Directors from time to time up to but not to exceed the maximum allowed by law from time to time, which is currently 5% of the installment due or Twenty-Five dollars (\$25.00) per late payment, whichever is greater. If not otherwise set by the Board of Directors, the maximum amount allowed by law shall be applicable. All payments shall be first applied to interest, then to late fees, attorneys' fees and costs and then lastly to the principal of the assessment first due and unpaid.

7.4 Lien for Assessments. The Association shall have a lien on each Unit, and its appurtenant undivided share of the Common Elements and Limited Common Elements, for any assessments unpaid when due, including interest, late fees, attorney's fees and costs as aforesaid, until all sums so owing are paid. Such lien shall also secure the payment by the Unit Owner of reasonable attorney's fees incurred by the Association by reason of or incident to the filing of Claim of Lien therefor, the collection of such assessment, and the enforcement of such lien,

which fees shall be due and owing by any Unit Owner whose assessment is unpaid and by reason of which such matter is placed in the hands of an attorney. A Claim of Lien for any such unpaid assessment, including such interest and attorney's fees, may be recorded by the Association in the Public Records of Pinellas County, Florida in such forms as deemed appropriate by the Association including but not limited to, name and address of owner of the Unit and Condominium Parcel involved, description of the Unit and Condominium Parcel, and amount of sums unpaid. Such lien may be enforced in the same manner as provided by Florida law for the enforcement of a mortgage lien against real property and as otherwise provided by the Condominium Act. Such lien shall relate back to the original date of recording this Declaration and shall be effective at the time of recording such Claim of Lien, and, to the extent permitted by law, such lien shall be superior to, and have priority over, all other parties having any claim or interest in the property and any claim of exemption under the Homestead Law or any other laws. In any event such lien shall be subordinate and inferior to that of a prior recorded first mortgage given to an institutional mortgagee but only to the extent provided by the Condominium Act.

VIII Association

8.1 Association. The operation of the Condominium shall be by Sunfish Bay Condominium Association, Inc., a non-profit corporation established under the laws of the State of Florida, which shall fulfill its functions pursuant to the provisions of this Declaration, including the following.

8.2 Articles of Incorporation. A copy of the Articles of Incorporation of the Association are attached hereto as Exhibit "B" and incorporated herein by this reference.

8.3 By-Laws. The By-Laws of the Association shall be the By-Laws of the Condominium, a copy of such By-Laws being attached hereto as Exhibit "C" and incorporated herein by this reference.

8.4 Limitation of Liability of Association and Unit Owners. Notwithstanding the duty of the Association to maintain and repair parts of the Condominium Property, and other property, the Association shall not be liable to Unit Owners for injury or damage, other than the cost of maintenance and repair, caused by any latent condition of the property to be maintained and repaired by the Association, or caused by the elements or by other owners or persons. The owner of a Unit shall have no personal liability for any damage caused by the Association or in connection with the use or maintenance of the Common Elements or in connection with the performance by the Association of any other Association responsibility provided for herein.

8.5 Restriction on Assignment of Shares and Assets. The share of members in the funds and assets of the Association cannot be assigned, hypothecated or transferred in any manner except as an appurtenance to his or her Unit.

8.6 Approval or Disapproval of Matter. Whenever a decision of a Unit Owner is required upon any matter, whether or not the subject of any Association meeting, such decision shall be expressed by the same person who would cast the vote of such Owner at an Association

meeting, unless the joinder of any and all record owners is specifically required by the Declaration.

IX Other Liens

9.1 Liens. Subsequent to recording this Declaration no liens of any nature shall thereafter arise or be created against the Condominium Property as a whole except with the unanimous consent of the Unit Owners. During such period liens may arise or be created only against the several Condominium Parcels.

9.2 Liens for Labor and Materials. Labor performed or materials furnished to a Unit shall not be the basis or the filing of a lien pursuant to the Mechanic's Lien Law against the Unit or Condominium Parcel of any Unit Owner not consenting to or requesting the same. No labor performed or materials furnished to the Common Elements or Limited Common Elements shall be the basis of a lien thereon, but if duly authorized by the Association, such labor or materials shall be deemed to be performed or furnished with the express consent of each Unit Owner and shall be the basis for the filing of a lien against all Condominium Units in the proportions for which the owners thereof are liable for Common Expenses.

9.3 Release of Lien. In the event a lien against more than one Condominium Unit becomes effective, each owner thereof may relieve his Condominium Unit of the lien by payment of the proportionate amount attributable to his Unit. Upon such payment it shall be the duty of the lienor to release the lien of record for such Condominium Unit, and such lien shall be so relieved and discharged by such payment.

X Insurance

10.1 Unit-Casualty.

(a) The Association shall take out and maintain on each Unit, and all portions of the structure of which each Unit is a part, fire, windstorm, extended coverage and other perils insurance in a company satisfactory to the Association in an amount equal to the full maximum insurable replacement value of each Unit and the structure of which each Unit is a part, such company to be duly qualified and authorized to do business in the State of Florida, which value shall be reviewed (and coverage changed accordingly) at least annually, to the satisfaction of the Association. Such policy, copy of which shall be deposited with the Secretary of the Association, shall protect the Association and, in standard form, any first mortgagee, as its interest may appear, and shall be payable as provided herein-below.

(b) The proceeds of said policy shall be made payable to the first mortgagee, if any, and if none, to the Association. In the event of any loss or damage from perils insured against as aforesaid, the Association shall forthwith diligently make and prosecute the insurance claim therefor and, upon payment of the proceeds, the party receiving said proceeds, as aforesaid, shall repair and rebuild the unit so as to restore it to a condition equal to or better than that existing prior to said loss or damage. Said restoration and rebuilding shall be in accordance

with the original plans and specifications for the unit unless otherwise consented to by the first mortgagee (if a first mortgage on the unit exists), by the Association, and by the Owner. If it is determined at any time by the Association that said proceeds are not sufficient to so restore the Unit and structure of which the Unit is a part, the amount of such insufficiency shall be owed by the Owner of the Unit and structure of which the unit is a part to the Association and, if said insufficiency remains unpaid after five (5) days following request therefor by the Association to said Unit Owner, assessment shall be made against the Unit Owner in an amount sufficient to provide such funds for such restoration. In the case of any such loss or damage to two or more units which are a part of one structure, liability for any said insufficiency shall be allocated among each owner of said units based upon the portion of said insufficiency necessary for the restoration and re-building of such owner's unit. The construction for such restoration of said premises shall be commenced within ninety (90) days from the date of said loss or damage and said work shall be pursued diligently until completion thereof.

(c) The premium for any insurance policy or policies taken out by the Association to fulfill the Association's responsibilities under this Declaration, and under said Articles of Incorporation and By-Laws, including the Association's responsibility under section 10.1 (a) above, shall be a Common Expense, liability for which is otherwise established by this Declaration, including Article VII hereof. The assessment provided for in section 10.1(b) above shall be due and payable fifteen (15) days after said assessment is imposed and shall be recoverable by the Association from the Unit Owner, together with the Association's costs and reasonable attorney's fees, through any remedy provided by law and in the same manner as otherwise provided in this Declaration, including Article VII, for recovery and enforcement of assessments.

10.2 Common Elements - Public Liability. The Association shall take out and maintain comprehensive public liability insurance in an amount determined and fixed by the Board of Directors of the Association covering the Common Elements, Limited Common Elements and other property in, or which serves, or the use of which is incident to, the Condominium. Such insurance shall insure the Association, its Board of Directors and Officers and Unit Owners against possible liabilities arising out of the use of the Common Elements, Limited Common Elements, all Units, and all other property which is maintained or used by the Condominium or the expense of maintenance of which is a Common Expense, such insurance to be in an amount not less than One Hundred Thousand Dollars/Three Hundred Thousand Dollars (\$100,000/\$300,000) Personal Injury and Twenty-Five Thousand Dollars (\$25,000) Property Damage.

10.3 Common Elements – Casualty. The Association shall take out and maintain fire, extended coverage and other perils insurance on any Common Elements, and other property in, or which serves, or is incident to, the Condominium, which consists of improvements and structures subject to casualty loss in an amount to be determined and fixed by the Board of Directors of the Association.

10.4 Workmen's Compensation. Workmen's Compensation insurance shall be carried by the Association to meet requirement of the law.

10.5 Other Insurance. The Association shall carry such other insurance as the Board of Directors shall determine from time to time to be desirable.

10.6 Premiums. Premiums on all insurance policies purchased by the Association shall be a Common Expense.

10.7 Insurance Policies. Each policy of insurance required by the provisions of this Article X to be taken out and maintained shall be placed with a reputable and reasonably sound insurer and through an insurance agent, designated by the Board of Directors.

10.8 Insurance Adjustments. Each Unit Owner shall be deemed to have delegated to the Board of Directors of the Association his right to adjust with insurance companies all losses under policies purchased by the Association.

XI Taxes and Assessments

11.1 Assessment on Condominium Parcels. Property taxes and special assessments assessed by governmental taxing authorities shall be assessed against and collected on the Condominium Parcels and not upon the Condominium Property as a whole.

XII Use Restrictions

12.1 Use Restrictions. The use of the Condominium Property shall be in accordance with the following provisions as long as the Condominium and any other adjacent or neighboring Condominiums within Sunfish Bay exist and any Unit therein is in useful condition. Such provisions are restrictive covenants which shall be complied with by all Unit Owners who are obligated also to take all reasonable steps to see that their guests and visitors, and any person coming or remaining on the Condominium Property at their instance, comply with such of the following provisions as are applicable to behavior and activities on the Condominium Property, including the various Units, Limited Common Elements and Common Elements.

12.2 Units. Each unit shall be occupied only by one family, its servants and guests, as a residence and for no other purpose. A home-based business shall be allowable within a residence only with prior notification to, and approval of, the Board of Directors. A garage space, or any other portion of the limited common or Common Elements of Sunfish Bay, may not be utilized for any business purpose. A business use shall not be allowed and shall be curtailed in the event of any of the following activities listed below occur:

(a) Frequent delivery and/or pick-up of packages by third party delivery services such as UPS or Federal Express.

(b) The keeping or storage of business inventory in the home or garage, which can be readily discernable from a casual observance of the home.

(c) Continual visitation of third parties whose intent is to conduct business upon the premises with the owner or occupant of the home, as opposed to a social guest or visitor.

(d) Any other activity, which shows a non-residential use of the Condominium Unit.

12.3 Changes. No Unit may be divided or subdivided into a smaller building(s) or Unit(s) nor may any portion thereof be sold or otherwise transferred as a portion and not as a part of the whole.

12.4 Condition of Units. Except for portions of units the maintenance and repair of which is the exclusive responsibility of the Association, all Unit Owners shall keep and maintain their units and all fixtures thereon and appurtenances thereto in a state of good condition and repair, wear and tear by time and weather and for any other cause notwithstanding, shall promptly pay for all utility services which are separately metered or charged to the Unit, and, notwithstanding any responsibility of the Association for maintenance and repair of portions of Units and of Limited Common Elements shall keep their units and the appurtenant Limited Common Elements in good condition in a state of neatness and cleanliness.

(a) After the recording of this amendment, the installation of any new floor coverings shall have adequate soundproofing material installed prior to the installation of the new floor covering. The adequacy of such soundproofing shall be determined in the sole and absolute discretion of the Board of Directors and the Board of Directors may ask for verification of the soundproofing through documents and/or visual inspection by a Board representative. If sound transmission is still determined in the sole and absolute discretion of the Board to be a nuisance, sufficiently sized area rugs shall be utilized to dampen the transmission of sound.

(b) In the event a unit shall be vacant for more than forty-eight (48) hours, the water supply to the unit shall be shut-off at the main shut-off valve so that no water is flowing to any part of the unit. Should any damage arise out of or result from the failure to shut-off the water when the unit is vacant for more than forty-eight (48) hours, the Unit Owner shall be strictly liable for the costs of any remediation necessary or damage sustained to the Common Elements or other units, in addition to any costs associated with remediating or repairing his or her own unit. In addition, failure to properly maintain any portion of the Unit or the plumbing or other lines servicing the single Unit which results in damage to another Unit or Units or to the Common Elements shall be the responsibility of the individual Unit Owner failing to properly maintain same. If a unit will be vacant for more than fourteen (14) days, the Unit Owner shall have someone check on the unit at least once a week to ensure that there are no problems or conditions within the unit that would indicate a need for repair and all conditions shall be promptly reported to the Association in the event the Association is responsible for maintenance or repair. The Association shall not be responsible for the costs of any remediation or repair necessary as a result of or arising from a failure to abide by this provision and any costs incurred by the Association to remediate water damage and/or resulting mold or mildew or to make repairs may be charged back to the Unit Owner and collected as a Special Assessment including, but not limited to, recording a Claim of Lien and ultimately foreclosing on same. Unit Owners shall be responsible for the costs of drying out the interior of their unit, including the drywall,

should same be necessary for any reason, whether occurring during a period when the water should have been shut-off or not.

Without regard to whether or not the unit is vacant at the time of the water overflow, seepage, intrusion, or the like, the Unit Owner shall be strictly liable for any damage resulting or arising from the overflow, seepage, dripping, leakage, or other flow of water from any plumbing fixture within the unit, including but not limited to, washing machines, toilets, sinks, hot water heaters, and icemaker lines and any costs incurred by the Association to remediate or make repairs after such an event may be charged back to the unit and Unit Owner as a Special Assessment and collected as an assessment including, but not limited to, recording a Claim of Lien and ultimately foreclosing on same.

12.5 Signs. Except for name plates identifying the Unit Owner, which shall be of uniform size and design as approved by the Board of Directors of the Association, no Unit Owner shall post, affix, or cause the placing or permit the placement or existence, of any signs on the Common Elements or Limited Common Elements or on or in any Unit, which sign is visible from the Common Elements or any part thereof or from a street, or from another Unit in this or any other Condominium, in the vicinity. Specifically, no "For Rent" or "For Sale" or like signs or insignia may be placed in, on or about a Unit.

12.6 Airing of Bedding, Etc. No clothing bedding, household furnishings, or like items shall be dried or aired in any outdoor area, except in an area constructed and placed in such manner as to be to visible to any substantial extent from the Common Elements or any part thereof or from a street, or from another Unit in this or any other Condominium, in the vicinity. Such outdoor areas must be approved in writing by the Board of Directors of the Association.

12.7 Nuisances. No nuisances shall be caused, or permitted to exist, by any owner in, on or about his Unit or on the Condominium Property, nor shall there be any use or practice which is the source of annoyance to residents or any of them or which interfere in any way with the peaceful possession and proper use by the residents or any of them of the Condominium Property of this or any other Condominium in the vicinity or any part thereof and of the Units therein or any of them. All parts of the Condominium, including each Unit and Limited Common Elements appurtenant thereto, shall be kept in a neat, clean and sanitary condition, and no rubbish, refuse or garbage shall be allowed by any Unit Owner or by anyone to accumulate, nor shall any fire hazard be so allowed to exist, provided that garbage and trash shall be kept in plastic containers (or containers of a similar non-noise generating quality) which shall be kept covered at all times and shall be located below the ground in locations and as otherwise approved by the Board of Directors of the Association or the management contractor employed by the Association for the maintenance of the Condominium, except that garbage and trash may be placed in such containers, or in some other neat and orderly fashion, on Limited Common Elements adjacent to the street on days designated by the Board of Directors of the Association for trash and garbage collection. Trash disposal for yard trimmings can be placed along the right of way on Bayshore Blvd. on days designated by the Board of Directors. The City of Clearwater designates the day of the week for pick-up and yard trimmings and other trash may be placed curbside the day before pick-up. No Unit Owner shall make or permit any use of his Unit or make or permit any use of the Common Elements or Limited Common Elements which will

increase or be likely to increase the cost of insurance upon the Condominium Property or any part thereof or Unit or building thereon.

12.8 Occupancy of Units. No one (1) bedroom Unit in the Condominium shall be permanently occupied at any time by more than two (2) individuals, and two (2) bedroom Unit shall be permanently occupied at any time by more than four (4) individuals. No three (3) bedroom Unit in the Condominium shall be permanently occupied by more than five (5) individuals. Children must have individual bedrooms available.

12.9 Visitors and Occupancy. Unit Owners, or lessees approved as provided hereinafter, shall not permit total occupancy of Units: i.e., Occupancy in the absence of such owners or lessees, by visitors or others for any period in excess of three (3) weeks, in the aggregate, during any six (6) month period; and at any time no one (1) bedroom Unit shall be occupied by more than five (5) persons, no two (2) bedroom Unit shall be occupied by more than six (6) persons, and no three (3) bedroom Unit may be occupied by more than seven (7) persons. This provision shall have no application to social gatherings not involving occupancy or residency.

12.10 Pets. Pets may be permitted and maintained in any Unit, provided, however, the Board of Directors of the Association may at any time terminate such privilege for any Unit Owner upon a determination by the Board that the maintenance of a pet is a nuisance or is an unreasonable annoyance to the Condominium, or to any other Condominium, or Unit thereof, in the vicinity. However, no pet may be permitted out of a Unit except for domesticated pets of the normal variety, such as dogs on a leash and in the charge of a resident or visitor. Maintenance and keeping of pets on the Condominium Property and in any Unit may be otherwise regulated in any manner, whether or not consistent herewith, by Rules and Regulations as may from time to time be established by the Board of Directors of the Association, which Rules and Regulations shall be subject to alteration by the membership of the Association at a duly constituted meeting as provided in the By-Laws.

(a) Unit Owners and lessees may maintain pets in the Units subject to the following limitations. Small birds, and fish kept in aquariums of less than fifty (50) gallons, are allowed. Within fifteen days of the effective date of the provision, all pets currently maintained within a Condominium Unit (with the exception of fish in aquariums and small birds) shall be registered with the Association. After the effective date of this provision, in addition to birds or fish as above noted, a maximum of two domesticated animals shall be allowed per Unit.

12.11 Employees of Management Contractor. No Unit Owner shall direct or supervise or attempt to assert any control or direction of any kind in any way over any employee of the management contractor or Association. The prohibitions this Section shall specifically apply to any attempt to use such employees for the private affairs of a Unit Owner or resident or visitor.

12.12 Service Requests. Any and all requests for service on and care and maintenance of the Condominium and all property therein, shall be made in writing directly to the management contractor subject to such reasonable Rules and Regulations as may be established in this regard from time to time by the Association.

12.13 Leasing. In the event of a proposed lease or lease renewal of a Condominium Unit, the owner shall submit a copy of the lease, and such other information as the Board may reasonably require, including an application fee of up to \$100.00 or another amount set by the Board of Directors, for consideration and approval by the Board. Submission of all such information shall be at least fourteen (14) days prior to the inception of the lease or lease renewal. Approval of a lease shall be granted within fourteen (14) days of the submission of the fully completed application form, and such other additional information as may be requested by the Board. The Association may consider a lessee's conduct and compliance with the Declaration, By-Laws and Rules, when reviewing an application for renewal. A Condominium Unit Owner may not lease the Unit for the initial twelve (12) months of ownership. After owning a Unit for a period of twelve (12) months, a Unit may be leased in accordance with all restrictions. All leases shall be for a term of not less than one (1) year. If a lessee vacates the Unit prior to the end of said one (1) year period, a new lease will not be accepted unless written approval is given by the Board of Directors, prior to signing of the lease.

(a) Only after approval by the Association, as elsewhere required herein, an entire Unit (and not a part thereof) may be rented provided the occupancy is only by the lessee and his family, its servants and guests, which lessee shall be subject to all restrictions, requirements and covenants provided herein on and for owners. No rooms may be rented except together with an entire Unit or to another Unit Owner.

(b) In an effort to protect the integrity of this restriction, any occupancy in the absence of the record owner shall be deemed to be a lease unless otherwise approved by the Board of Directors in writing acknowledging that the occupancy is by family members as established by documentation satisfactory to the Board of Directors or friends who shall in no event be permitted to occupy a unit in the absence of the record Unit Owner for a period in excess of fourteen (14) consecutive days. All occupancy in the absence of the record Unit Owner shall require advance notice to the Board of Directors, completion of such forms as may be required by the Board from time to time, and the written approval of the Board prior to occupancy.

(c) The Board shall have the power pursuant to Chapter 83 of the Florida Statutes to evict as an agent for the owner any lessee or occupant for their failure to comply with the governing documents of the Association, which include this Declaration, the Articles of Incorporation, the By-Laws, and Rules and Regulations of the Association. This shall include the ability to evict any unapproved lessee. The owner shall cooperate fully with the Association in any eviction proceeding. The Association shall not be deemed a landlord for any other purpose other than the right to evict under Chapter 83 of the Florida Statutes. Any attorney fees and costs incurred in pursuing an eviction shall be assessed against the owner and/or the owner's unit and may be collected in the same manner as an assessment.

12.14 Antennas and Aerials. All exterior T.V. antennas, and the like, must be of a type and in a location approved by the Association. However if at any time cable television (CATV) is made available, no exterior T.V. antenna may be used on any unit or Limited Common Elements appurtenant thereto without the consent of the Association. Such other adjacent or neighboring Condominiums, or Condominiums in the vicinity, and the like, as referred to in this

section and elsewhere in this Declaration include, but shall not necessarily be limited to, all Condominiums planned by Developer as a part of the Sunfish Bay Condominium development on the approximately fourteen (14) acre tract adjacent to Bayshore Boulevard, Clearwater, Pinellas County, Florida of which the property on which this Condominium is located is a part and shall include such Condominiums, the Declarations of which provide for Unit Owners membership in the Association referred to in Article VIII hereof.

12.15 Parking. There shall be no vehicles kept or parked in carports or parking spaces except passenger vehicles. More specifically, there shall be no boats or trailers or campers, commercial trucks, buses, motor homes, mobile homes, and commercial vehicles parked in carports or parking spaces or on the Condominium premises nor shall there be any storage in carports of items, other than passenger vehicles, exposed to view at any time from the Common Elements or from other Units in this or other adjacent or neighboring Condominiums. There shall be no parking on the streets or elsewhere in, or in the vicinity of, this or any adjacent or neighboring Condominium, except in areas designated for same from time to time by the Association.

(a) No vehicle exceeding the dimensions of 6½ feet in width by 18½ feet in length and 6½ feet in height may be permitted to park on any of the Condominium properties.

(b) Only passenger vehicles which are used for private non-commercial use shall be permitted to be parked on the Sunfish Bay Condominium Property. "Commercial use" shall be determined by any commercial markings, signs, displays, or otherwise, which indicates a commercial use when viewing the vehicle from the exterior.

(c) ANY VEHICLE VIOLATING ANY PROVISION OF THIS SECTION SHALL BE TOWED AT THE OWNER'S EXPENSE.

12.16 Lawful Use. No immoral, improper, offensive, or unlawful use shall be made of any unit or of the Condominium Property or any part thereof, and all valid laws, zoning ordinances and regulations of all governmental bodies having jurisdiction thereof shall be observed.

12.17 Regulations. Other reasonable Rules and Regulations concerning the use of Units and the Condominium Property, not substantially inconsistent herewith, except as allowed herein, may be made and amended from time to time by the Association. Copies of such Regulations and Amendments shall be furnished by the Association to all Unit Owners and residents of the Condominium upon request and may be made available on the website.

XIII

Maintenance of Community Interests

13.1 Community Interest. In order to maintain a community of congenial residents who are financially responsible and thus protect the value of the Units, the transfer of Units by any owner shall be subject to the following provisions as long as the Condominium and any

other Condominium within the Sunfish Bay Condominium development exists and any Unit therein is in useful condition, which provisions each Unit Owner covenants to observe:

13.2 Transfers Subject to Approval.

(a) Sale. No Unit Owner may dispose a Unit or Condominium Parcel or any interest therein by sale without approval of Association, except to a Unit Owner.

(b) Lease. Except as otherwise provided in Section 12.13 above, no Unit Owner may dispose of a Unit or Condominium Parcel or any interest therein by lease without approval of the Association except to a Unit Owner.

(c) Gift. If any Unit Owner shall acquire his title by gift, the continuance of his ownership of the Unit and Condominium Parcel shall be subject to the approval of the Association.

(d) Devise or Inheritance. If any Unit Owner shall acquire his title by devise or inheritance the continuance of his ownership of his Unit and Condominium Parcel shall be subject to the approval of the Association.

(e) Other Transfers. If any Unit Owner shall acquire his title to a Unit or Condominium Parcel, or an interest therein, by any manner not considered in the foregoing subsections, the continuance of his ownership therein shall be subject to the approval of the Association.

13.3 Approval by Association. The approval of the Association that is required for the lease, transfer, disposal or continuation of ownership or any interest as provided above shall be obtained in the following manner (the terms "Unit" and "Unit Owner" hereinabove and herein - below shall also mean, respectively, "Condominium Parcel" and "condominium owner"):

(a) Notice to Association.

(1) Sale: A Unit Owner intending to make a bona fide sale of his Unit or any interest therein shall give the Association notice of such intention, together with the name and address of the intended purchaser and such other information concerning the intended purchaser as the Association may reasonable require. Such notice at the Unit Owner's option may include a demand by the Unit Owner that the Association furnish a purchaser of the Unit if the proposed purchaser is not approved; and if such demand is made, the notice shall be accompanied by an executed copy of the proposed contract to sell.

(2) Lease: A Unit Owner intending to make a bona fide lease of his Unit or any interest therein shall give to the Association notice of such intention, together with the name and address of the intended lessee, such other information concerning the intended lessee as the Association may reasonably require and an executed copy of the proposed lease.

(3) Gift, Devise or Inheritance: Other Transfers: A Unit Owner who has obtained his title by gift, devise or inheritance, or by any other manner not previously considered, shall give to the Association notice of the acquiring of his title, together with such information concerning the Unit Owner as the Association may reasonably require and a certified copy of the instrument evidencing the owner's title.

(4) Failure to Give Notice: If the above required notice to the Association is not given, then at any time after receiving knowledge of a transaction or event transferring ownership or possession of a Unit, the Association at its election and without notice may approve or disapprove the transaction of ownership. If the Association disapproves the transaction or ownership, the Association shall proceed as if it had received the required notice on the date of such disapproval.

(b) Certificate of Approval.

(1) Sale: If the proposed transaction is a sale, then within thirty (30) days after receipt of such notice and information the Association must either approve or disapprove the proposed transaction. If approved, the approval shall be stated in a certificate executed by the President and Secretary of the Association in recordable form which shall be recorded in the Public Records of Pinellas County, Florida, at the expense of the purchaser.

(2) Lease: If the proposed transaction is a lease, then within thirty (30) days after receipt of such notice and information the Association must either approve or disapprove the proposed transaction. If approved, the approval shall be stated in a certificate executed by the President and Secretary of the Association in recordable form, which at the election of the Association, shall be delivered to the lessee or shall be recorded in the Public Records of Pinellas County, Florida, at the expense of the lessee.

(3) Gift, Devise or Inheritance: Other transfers: If the Unit Owner giving notice has acquired his title by gift, devise or inheritance or in any other manner, then within thirty (30) days after receipt of such notice and information the Association must either approve or disapprove the continuance of the Unit Owner's ownership of his Unit. If approved, the approval shall be stated in a certificate executed by the President and Secretary of the Association in recordable form, which shall be recorded in the Public Record of Pinellas County, Florida, at the expense of the Unit Owner.

(4) Approval of Corporate Owner or Purchaser: Inasmuch as the Condominium may be used only for residential purposes and a corporation cannot occupy a Unit for such use, if the Unit Owner or purchaser of a Unit is a corporation, the approval of ownership by the corporation may be conditioned by requiring that all persons occupying the Unit be approved by the Association.

13.4 Disapproval by Association. If the Association shall disapprove a transfer or ownership of a Unit, the matter shall be disposed of in the following manner:

(a) Sale: If the proposed transaction is a sale and if the notice of sale given by the Unit Owner shall so demand, then within thirty (30) days after receipt of such notice and information the Association may deliver or mail by registered mail to the Unit Owner an agreement to purchase the Unit concerned by a purchaser approved by the Association who will purchase and to whom the Unit Owner must sell the Unit upon the following terms:

(1) At the option of the purchaser to be stated in the agreement, the price to be paid shall be that stated in the disapproved contract to sell or shall be the fair market value determined by arbitration in accordance with the then existing rules of the American Arbitration Association, except that the arbitrators shall be two appraisers appointed by the American Arbitration Association who shall base their determination upon an average of their appraisals of the Unit; and a judgement of specific performance of the sale upon the award rendered by the arbitrators may be entered in any court of competent jurisdiction. The expense of the arbitration shall be paid by the purchaser.

(2) The purchase price shall be paid in cash.

(3) The sale shall be closed within thirty (30) days after the delivery or mailing of the agreement to purchase, or within ten (10) days after the determination of the sale price if such is by arbitration, whichever is the later.

(4) A certificate of the Association executed by its President and Secretary and approving the purchaser shall be recorded in the Public Records of Pinellas County, Florida, at the expense of the purchaser.

(5) If the Association shall fail to provide a purchaser upon the demand of the Unit Owner in the manner provided or if a purchaser furnished by the Association shall default in his agreement to purchase, then notwithstanding the disapproval, the proposed transaction shall be deemed to have been approved and the Association shall furnish a certificate of approval as elsewhere provided, which shall be recorded in the Public Records of Pinellas County Florida, at the expense of the purchaser.

(6) To the extent that the disapproval is based upon the purchasers status as a registered sex offender or sexual predator or as a convicted felon for a felony conviction within the ten (10) year period immediately preceding his or her application for approval, the Association shall have the absolute right to deny the purchaser and shall have no obligation to provide an alternate purchaser.

(b) Lease: If the proposed transaction is a lease, the Unit Owner shall be advised of the disapproval in writing and the lease shall not be made.

(c) Gifts, Devise, or Inheritance: Other Transfers: If the Unit Owner giving notice has acquired his title by gift, devise or inheritance, or any other manner, then within thirty (30) days after receipt from the Unit Owner of the notice and information required to be furnished, the Association may deliver or mail by registered mail to the Unit Owner an

agreement to purchase the Unit concerned by a purchaser approved by the Association who will purchase and to whom the Unit Owner must sell the Unit upon the following terms:

(1) The sale price shall be the fair market value determined by agreement between the seller and purchaser within thirty (30) days from the delivery or mailing of such agreement. In the absence of agreement as to price, the price shall be determined by arbitration in accordance with the then existing rules of the American Arbitration Association except that the arbitrators shall be two appraisers appointed by the Americans Arbitration Association who shall base their determination upon an average of their appraisals of the Unit; and a judgment of specific performance of the sale upon the award rendered by the arbitrators may be entered in any court of competent jurisdiction. The expense of the arbitration shall be paid by the Purchaser.

(2) The purchase price shall be paid in cash.

(3) The sale shall be closed within ten (10) days following the determination of the sale price.

(4) A certificate of the Association executed by its President and Secretary and approving the purchaser shall be recorded in the Public Records of Pinellas County, Florida, at the expense of the purchaser.

(5) If the Association shall fail to provide a purchaser as required by this instrument, or if a purchaser furnished by the Association shall default in his agreement to purchase, then notwithstanding the disapproval such ownership shall be deemed to have been approved, and the Association shall furnish a certificate of approval as elsewhere provided, which shall be recorded in the Public Records of Pinellas County, Florida at the expense of the Unit Owner.

(d) The Board of Directors may disapprove a proposed sale or lease or occupancy of a Unit based upon considerations for the health, safety, and general welfare of the Community; however, nothing herein shall be construed to create an obligation of the Association to ensure that the Community is free from criminals or individuals that may pose a threat to the health, safety, or general welfare of the residents, and the Association shall not be liable for failure to run background checks or to deny any proposed tenant or occupant based upon the contents of any background report received. Reasons for disapproval may include, but are not limited to:

(1) Prior criminal record, including any pleas of no contest, which indicates a potential threat to the health, safety or welfare of the Community;

(2) Non-compliance with any specific requirements set forth in the Association's Governing Documents, including any rules and regulations;

(3) Providing false or incomplete information in connection with an application; or

(4) Status as a registered sex offender or sexual predator.

13.5 Mortgage. No Unit Owner may mortgage his Unit or any interest therein without the approval of the Association except to a bank, Life Insurance Company or a savings and loan association or to a vendor to secure a portion or all of the purchase price. The approval of any other mortgagee may be upon conditions determined by the Association or may be arbitrarily withheld.

13.6 Exceptions. The foregoing provisions of this Section entitled "Maintenance of Community Interests" shall not apply to a transfer to or purchase by a bank, life insurance company or savings and loan association which acquires its title as the result of owning a mortgage upon the Unit concerned, and this shall be so whether the title is acquired by deed from the mortgagor, his successors or assigns, or through foreclosure proceedings; nor shall such provisions apply to a transfer, sale or lease by a bank, life insurance company or savings and loan association which so acquires its title. Neither shall such provisions require the approval of a purchaser who acquires the title to a Unit at a duly advertised public sale with open bidding provided by law, such as, but not limited to, execution sale, foreclosure sale, judicial sale or a tax sale.

13.7 Unauthorized Transactions. Any sale, mortgage or lease not authorized pursuant to the terms of this Declaration shall be void unless subsequently approved by the Association.

XIV Compliance and Default

14.1 Each Unit Owner except as otherwise provided herein or in the Articles of Incorporation or By-Laws of the Association, shall be governed by and shall comply with the terms of this Declaration of Condominium, the Articles of Incorporation and By-Laws of the Association and the rules and regulations adopted by the Association pursuant to those documents and all of such as they may be amended from time to time. Failure of a Unit Owner to so comply with such documents, rules and regulations shall entitle the Association or other Unit Owners to the following relief in addition to the remedies provided by the Condominium Act.

(a) Negligence. A Unit Owner shall be liable for the expense of any maintenance, repair or replacement rendered necessary by his negligence or by that of any member of his family or his or their guests, employees, agents or lessees, but only to the extent that such expense is not met by the proceeds of insurance carried by the Association. A Unit Owner shall pay the Association the amount of any increase in its insurance premiums occasioned by use, misuse occupancy or abandonment of a Unit or its appurtenance or of the Common Elements, by the Unit Owner.

(b) Costs and Attorneys' Fees. The Association shall be entitled to recover any non-litigation or pre-litigation fees incurred as a result of hiring legal counsel to enforce this Declaration, Articles of Incorporation, By-Laws and any rules and regulations of the Association where there is a failure to comply after notice of the violation from the Association. Further, in any proceeding arising because of an alleged failure of a Unit Owner or the Association to

comply with the terms of the Declaration, the Articles of Incorporation or By-Laws of the Association, or the rules and regulations adopted pursuant to them, and those documents and rules and regulations as they may be amended from time to time, the prevailing party shall be entitled to recover the costs of the proceeding and such reasonable attorneys' fees as may be awarded by the Court, including those incurred in any appellate proceedings.

(c) No Waiver of Rights. The failure, at any time or from time to time, of the Association or any Unit Owner to enforce any covenant restriction or other provision of the Condominium Act, this Declaration, the Articles of Incorporation or By-Laws of the Association or the rules and regulations adopted pursuant thereto or those documents and rules and regulations as they may be amended from time to time shall not constitute a waiver of the right to do so thereafter.

XV Amendments

16.1 Amendments. Except as otherwise provided herein, amendments to the Declaration of Condominium may be made in accordance with the procedure hereinafter provided.

16.2 Notice. Notice of the subject matter of a proposed amendment shall be included in the notice of any meeting of the Association at which a proposed amendment is considered.

16.3 Resolution. A resolution of the Association adopting a proposed amendment may be proposed either by the Board of Directors of the Association or by the members of the Association.

16.4 Adoption of Resolution. In order for a resolution adopting a proposed amendment to become effective it must be approved as hereinafter set out. (Members not present in person or by proxy at the meeting considering the amendment may express their approval in writing provided such approval is on file with the Secretary prior to the meeting.) Said resolution must be approved by the affirmative vote of at least two-thirds (2/3) of the Owners within this Condominium, in person or by proxy, and voting at a meeting of the Unit Owners of this Condominium. The term "owner" or "Unit Owner" as used in this subsection (a) shall refer only to owner of a unit in this Condominium and shall not refer to owners of Units in other Condominium governed by this Association. Provided, no amendment shall be effective without the approval of at least two-thirds (2/3) of the Owners within each of the other Condominiums within the Sunfish Bay Condominiums Development.

16.5 Proviso. Provided, however, that no amendment adopted under the provisions of this Article XV shall discriminate unreasonably against any Unit Owner or against any Unit or class or group of Units, unless the Unit Owners so affected shall consent and no such amendment shall increase the number of Units or alter the boundaries of the Common Elements or alter the share in the Common Elements, appurtenant to a Unit or increase the owner's share of the Common Expenses, unless the record owner of the Unit concerned and all record owners of a first mortgage on such Unit shall join in the execution of the Amendment. Neither shall an

amendment make any change in the Sections 10.1, 10.3 and 10.6 under "Insurance" herein above unless the record owners of all mortgages upon the Condominium as a whole shall join in the execution of the amendment.

16.6 Recording. A copy of each amendment shall be attached to a certificate certifying that the amendment was duly adopted, which certificate shall be executed by the President and Secretary of the Association with the formalities of a deed. The amendment shall be effective when such certificate and copy of the amendment are recorded in the Public Records on Pinellas County, Florida.

XVI Termination

17.1 Termination. The Condominium may be terminated in the following manner.

17.2 Agreement. The Condominium may be terminated at any time by the approval in writing of all record owners of Units and all record owners of mortgages on Units. If the proposed termination is submitted to a meeting of the members of the Association, the notice of the meeting shall give notice of the proposed termination, and if the approval of the owners of not less than Seventy-Five Percent (75%) of the Common Elements, and of the record owners of all mortgagees upon the Units, are obtained in writing not later than thirty (30) days following the date of such meeting, then the approving owners shall have an option to buy all the Units, and Condominium Parcels, of the other owners for the period ending on the sixtieth (60th) day from the date of such meeting. Such approvals shall be irrevocable until the expiration of the option, and if the option is exercised, the approvals shall be irrevocable. The option shall be on the following terms:

(a) Exercise of Option. The option shall be exercised by delivery or mailing by registered mail to each of the record owners of the Units to be purchased an agreement to purchase signed by the record owners of Units who will participate in the purchase. Such agreement shall indicate which Units will be purchased by each participating owner and shall require the purchase of all Units owned by owners not approving the termination, but the agreement shall effect a separate contract between each seller and his purchaser.

(b) Price. The sale price for each Unit, and Condominium Parcel, shall be the fair market value determined by agreement between the Seller and Purchaser within thirty (30) days from the delivery or mailing of such agreement, and in the absence of agreement as to price, it shall be determined by arbitration in accordance with the then existing rules of the American Arbitration Association, except that the arbitrators shall be two (2) appraisers appointed by the American Arbitration Association who shall base their determination upon an average of their appraisals on the Unit; and a judgement of specific performance of the sale upon the award rendered by the arbitrators may be entered in any court of competent jurisdiction. The expense of arbitration shall be paid by the purchaser.

(c) Payment. The payment price shall be paid in cash.

(d) Closing. The sale shall be closed within ten (10) days following the determination of the sale price.

17.3 Certificate. The termination of the Condominium is either of the foregoing manners shall be evidenced by a certificate of the Association executed by its President and Secretary certifying as to facts affecting the termination, which certificate shall become effective upon being recorded in the Public Records of Pinellas County, Florida.

17.4 Shares of Owners After Termination. After termination of the Condominium, the Unit and Condominium Parcel owners shall own the Condominium Property and all assets of the Association as tenants in common in undivided shares that shall be the same as the undivided shares in the Common Elements appurtenant to the owners' Units prior to the termination. However, unless such termination is specifically approved by vote of Seventy-Five Percent (75%) of all Unit Owners in the Association, to-wit, all owners of Units in this and other Condominiums in said vicinity which are operated by the Association, at a duly called and constituted meeting of the Association, all Owners of such shares, and their assigns, and the property so owned shall remain subject to all of the obligations of Unit Owners and their property under the provisions of this Declaration, including specifically, but by no means limited to, the provisions of Articles IV, VI, VII, VIII, X, XII, and XIII, it being recognized that all of said Condominiums, and the ownership interests in property therein, are united for management purposes through the Association and through mutual covenants and commitments, including those contained in this Declaration, on which owners of Units in all of said Condominiums have relied and will rely.

XVII
Severability

18.1 The invalidity in whole or in part of any covenant or restriction, or any section, subsection, sentence, clause, phrase or word, or other provision of the Declaration of Condominium and the Articles of Incorporation, By-Laws and rules and regulations of the Association shall not affect the validity of the remaining portions.

(END OF AMENDED AND RESTATED DECLARATION OF CONDOMINIUM)

Exhibit A

SUNFISH BAY CONDOMINIUM 2

CITY OF CLEARWATER, PINELLAS COUNTY, FLORIDA
 BEING A CONDOMINIUM IN A PART OF GOVERNMENT LOT 2, IN SECTION 10, TOWNSHIP
 29S, RANGE 18E, AND A PART OF SECTION 9, TOWNSHIP 29S, RANGE 18E.

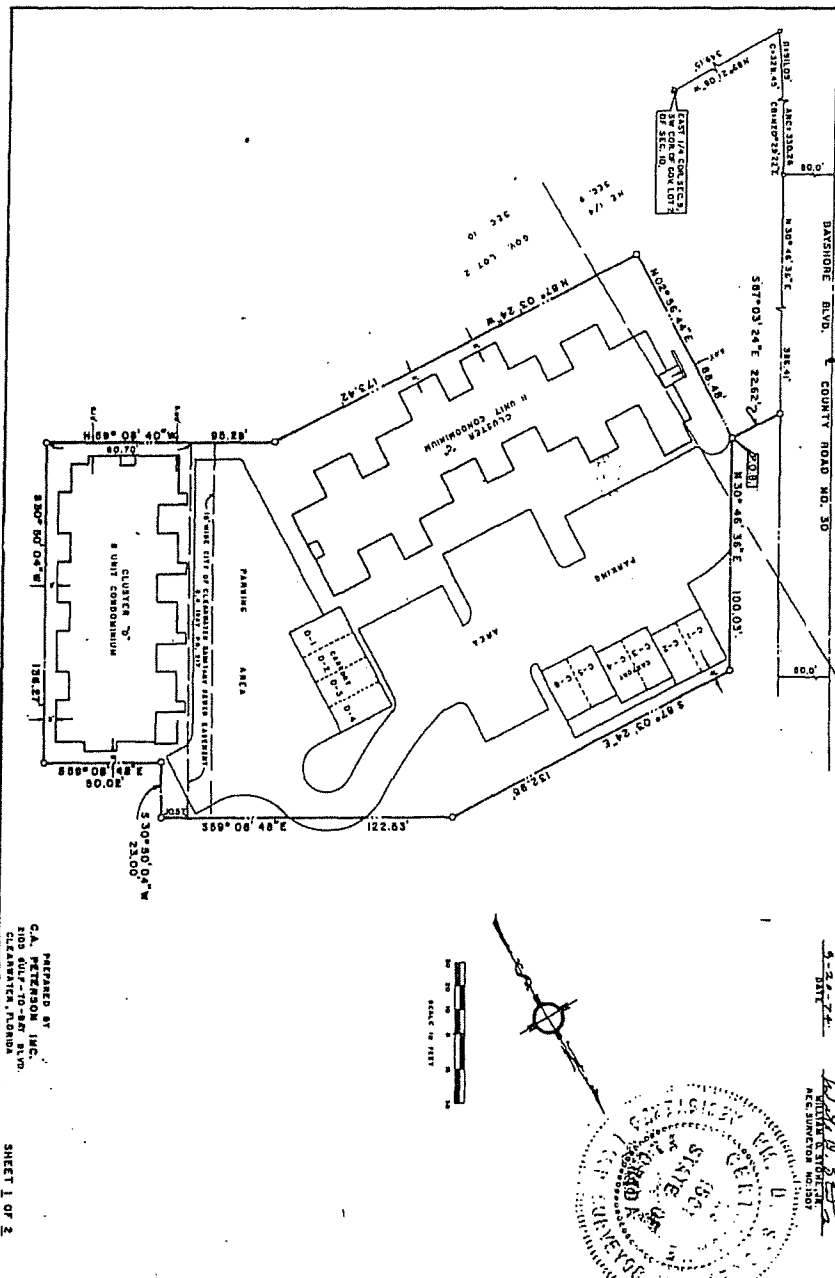

DESCRIPTION
 THAT PORTION OF GOVERNMENT LOT 2, IN SECTION 10, TOWNSHIP 29S, RANGE 18E, AND ALSO THAT PART OF THE
 ORIGINAL LOTS 1 AND 2, IN SECTION 9, TOWNSHIP 29S, RANGE 18E, LYING AND ADJOINING THE COUNTY ROAD NO. 50
 SAID GOVERNMENT LOT 2 AND ALSO THAT PORTION OF GOVERNMENT LOT 2, IN SECTION 10, TOWNSHIP 29S, RANGE 18E,
 CHORD BEARING S 87° 03' 24\"/>

SURVEYOR'S CERTIFICATE
 I, JAMES H. WILSON, LICENSED SURVEYOR, NUMBER 10000, STATE OF FLORIDA, DO HEREBY CERTIFY THAT A SURVEY WAS MADE OF THE LAND AS SHOWN
 HEREON AND THAT THE PLAN FOR THE CONDOMINIUM WAS PREPARED AND FILED WITH THE RECORDS
 OF THE COUNTY OF PINELLAS, FLORIDA, IN ACCORDANCE WITH THE PROVISIONS OF CHAPTER 718,
 PUBLIC RECORDS OF PINELLAS COUNTY, FLORIDA, IS A CORRECT
 AND TRUE REPRESENTATION OF THE SURVEY MADE AND THE DIMENSIONS AND SITE OF THE COMMON ELEMENTS AND OF
 EACH CONDOMINIUM UNIT HEREON.
 JAMES H. WILSON
 LICENSED SURVEYOR NO. 10000
 5-22-74



PREPARED BY JHC
 RFD 6047-10-87 B.M.
 CLEARWATER, FLORIDA

SHEET 1 OF 2

EXHIBIT "A"

Exhibit A

SUNFISH BAY CONDOMINIUM 2

CLUSTER "C"
11 UNITS

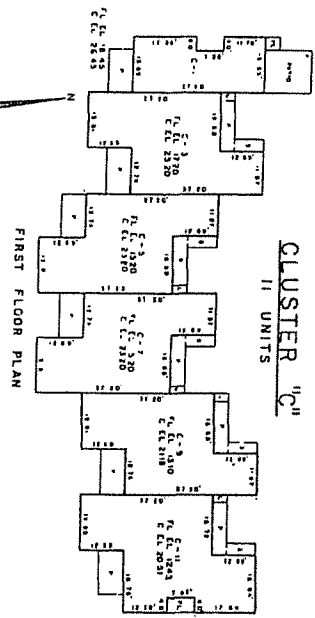

FIRST FLOOR PLAN

CLUSTER "D"
8 UNITS

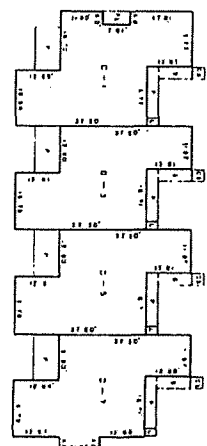

FIRST FLOOR PLAN

10.20
17.20



SECOND FLOOR PLAN

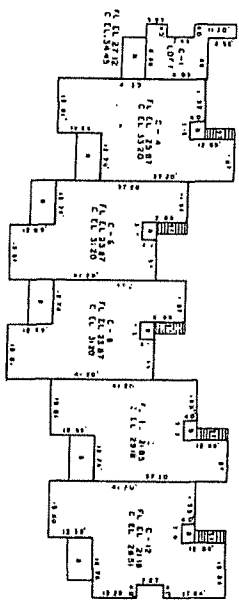

SECOND FLOOR PLAN

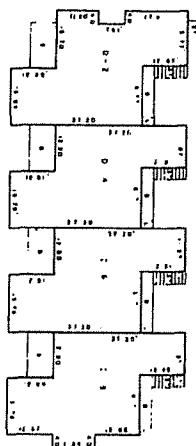

LOFT PLAN

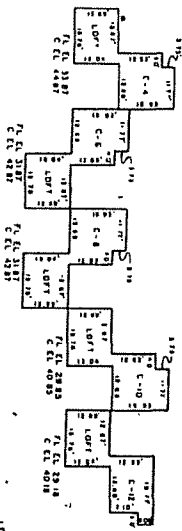

LOFT PLAN

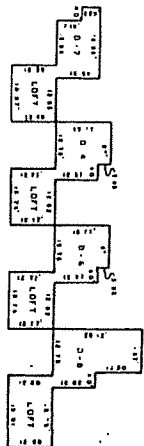

LEGEND
KITCHEN SLAB
P. 1 BALCONY
S. 1 STAIRS
L. 1 LAUNDRY
C. EL. CEILING ELEVATION

PREPARED BY
G.A. PETERSON, INC.
COLUMBIANA, OHIO

SHEET 2 OF 2

ARTICLES OF INCORPORATION
OF
SUNFISH BAY CONDOMINIUM ASSOCIATION, INC.

The undersigned by these Articles hereby associate themselves for the purpose of forming a corporation not for profit under Chapter 617 of Florida Statutes and certify as follows:

ARTICLE I

NAME

1.1 Name. The name of the corporation shall be SUNFISH BAY CONDOMINIUM ASSOCIATION, INC. For convenience the corporation shall herein be referred to as the Association.

ARTICLE II

PURPOSE

2.1 Purpose. The purpose for which the Association is organized is to provide an entity for the operation of SUNFISH BAY CONDOMINIUM I, a condominium located upon the property in Pinellas County, Florida described in Exhibit "A" attached hereto, and for the operation of other condominiums adjacent to said condominium and not adjacent but in the vicinity thereof, being or to be developed by the Developer referred to in the Declaration of said condominium, or its assigns, and the Declarations of which may provide for operation thereof by this Association. Although SUNFISH BAY CONDOMINIUM I and each of such other condominiums is and shall be a self-contained condominium and there shall be no merger of the common elements of said condominium and such other condominiums, all of said condominiums may be united for management purposes through this Association.

2.2 Distribution of Income. The Association shall make no distributions of income to its Members, Directors or Officers.

ARTICLE III

POWERS AND DUTIES

3.1 Common Law and Statutory Powers. The Association shall have all of the common law and statutory powers of a corporation not for profit not in conflict with the terms of these Articles of Incorporation.

3.2 Specific Powers and Duties. The Association shall have all the powers and duties set forth in the Condominium Act of the State of Florida and in these Articles of Incorporation and the Declaration of Condominium of SUNFISH BAY CONDOMINIUM I and the Declarations of the foregoing other condominiums.

Exhibit
B

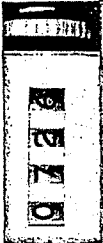

FILED
00130
DEPARTMENT OF
HALLAND
COUNTY
FLORIDA

and all of the powers and duties reasonably necessary to operate the condominium(s) pursuant to such Declaration(s) as it (or they) may be amended from time to time, except as such powers and duties under such Act may be limited by these Articles of Incorporation and said Declarations, including, but not limited to, the following:

- (a) To make and collect assessments against Members as Unit Owners to defray the cost, expenses and losses of the Condominium and to so assess in sums sufficient to permit the operation of the condominiums in a first-class and efficient manner and to permit their maintenance as first-class condominium communities, the cost and expense of so operating and maintaining the condominiums being common expenses thereof.
- (b) To use the proceeds of assessments in the exercise of its powers and duties.
- (c) To maintain, repair, replace and operate in a first-class manner and condition the condominium property, which shall include Units and common elements as defined and provided for in the Declarations, and, as determined by its Board of Directors, to enter into contracts with a Management Contractor or third parties for the performance of the foregoing and for the maintenance, repair, replacement and operation of the common elements of such condominiums and of streets and other facilities used by such condominiums, whether or not such streets and facilities are located on the condominium property.
- (d) To purchase insurance upon the condominium property and insurance for the protection of the Association, its Officers and Directors, and its Members as Unit Owners.
- (e) To reconstruct improvements after casualty and to further improve the property.
- (f) To make and amend rules and regulations respecting and governing the use of the property in the condominiums so long as not substantially inconsistent with the Condominium Declarations.
- (g) To approve or disapprove the sale, leasing or rental of Units in SUNFISH BAY CONDOMINIUM I and such other condominiums.
- (h) To enforce by legal means the provisions of the Condominium Act of the State of Florida, the Declaration of Condominium of SUNFISH BAY CONDOMINIUM I, such other Declarations, these Articles of Incorporation, the By-Laws of the Association and the Regulations for the use of the property in the Condominiums.
- (i) To contract through its Board of Directors for the management of the Condominiums and to delegate to such contractor, to the extent permitted by law, all powers and duties of the Association, except such as are specifically required by the Declaration of Condominium of SUNFISH BAY CONDOMINIUM I, and such other Declarations, to have approval of the Board of Directors or the Membership of the Association and in consideration for such Management Contract guaranteeing the operation and maintenance of the condominium during the first year of operation of the condominium in exchange for such monthly assessments as may be then due and payable, the Association may provide in the Management Contract that the Management Contractor need not render an accounting to the Association for such period.

(j) To employ personnel to perform the services required for proper operation of the condominiums.

(k) To make arrangements for garbage and trash pickups.

(l) To receive from Developer, at such time as Developer may in its discretion determine before or at any time following completion of said condominiums, and all units therein, conveyance of any land or property located on or in the approximately 14-acre tract on which said condominiums are located, except for the property which is a part of said condominiums, and of any other property which may serve, or be available to serve, said condominiums or any of them.

3.3 Assets Held in Trust. All funds and the title of all properties acquired by the Association and the proceeds thereof shall be held in trust for the members in accordance with the provisions of the Declaration of Condominium of SUNFISH BAY CONDOMINIUM I, such other Declarations, these Articles of Incorporation and the By-Laws of the Association.

3.4 Limitation on Exercise of Powers. The powers of the Association shall be subject to and shall be exercised in accordance with the provisions of the Declaration of Condominium of SUNFISH BAY CONDOMINIUM I, such other Declarations and the By-Laws of the Association.

ARTICLE IV

MEMBERS

4.1 Members. The Members of the Association shall consist of all of the record Owners and holders of Units in the Condominium, and said other condominiums, including the Developer.

4.2 Change of Membership. After receiving approval of the Association required by the Declaration of Condominium (which term shall hereinafter mean the Declaration specifically described in 3.2 above and the other Declarations referred to therein), change of membership in the Association shall be established by the recording in the Public Records of Pinellas County, Florida, a deed or other instrument establishing a change of record title to a Unit in the Condominium (which term shall hereinafter include the Condominium specifically described in 2.1 above and the other condominiums referred to therein) and the delivery to the Association of a certified copy of such instrument. The owner designated by such instrument thereby becomes a Member of the Association, and the membership of the prior owner is terminated, subject to the provisions of the Declaration of Condominium.

4.3 Limitation on Transfer of Share of Assets. The share of a Member in the funds and assets of the Association cannot be assigned, hypothecated or transferred in any manner, except as an appurtenance to the Member's Unit.

4.4 Voting. The Owner or Owners of each Unit shall be entitled to one vote for each Unit owned as a Member of the Association. The term "owner" of a Unit, as used in this section 4.4 and in section 4.1 above, shall include and mean the Developer regarding Units until such time as same have been sold by the Developer.

ARTICLE V

DIRECTORS

5.1 Board of Directors. The affairs of the Association shall be managed

by a Board consisting of a number of directors determined by the By-Laws but not less than three (3) Directors, and in the absence of such determination shall consist of three (3) Directors. Directors need not be Members of the Association.

5.2 Election of Directors. Except as otherwise provided herein, Directors of the Association shall be elected at the annual meeting of the Members, and Directors may be removed and vacancies on the Board of Directors shall be filled in the manner provided by the By-Laws of the Association.

5.3 First Election of Directors. The first election of Directors shall not be held until after the Developer has closed the sale of all of the Units of the Condominiums referred to in Article II, Sec. 2.1 or until Developer elects to terminate his control of the Condominiums, or until after January 1, 1993, whichever occurs first. The Directors named in these Article's shall serve until the first election of Directors and any vacancies in their number occurring before the first election shall be filled by the remaining Directors or, if none, by the Developer.

5.4 First Board of Directors. The names and addresses of the Members of the first Board of Directors who shall hold office until their successors are elected and have qualified, or until removed, are as follows:

<u>NAME</u>	<u>ADDRESS</u>
David G. Tibma	4801 Culbreath Isles Way Tampa, Florida 33609
Allen B. Carr	1564 Santa Monica Dunedin, Florida 33528
Sandra G. Carr	1564 Santa Monica Dunedin, Florida 33528

UNOFFICIAL COPY

ARTICLE VI
OFFICERS

6.1 Officers. The affairs of the Association shall be administered by Officers designated in the By-Laws of the Association. The Officers shall be elected by the Board of Directors at its first meeting following the annual meeting of the Members of the Association and shall serve at the pleasure of the Board of Directors. The names and addresses of the Officers who shall serve until their successors are designated by the Board of Directors are as follows:

<u>NAME</u>	<u>ADDRESS</u>
David G. Tibma	President 4801 Culbreath Isles Way Tampa, Florida 33609
Allen B. Carr	Vice-Pres. 1564 Santa Monica Dunedin, Florida 33528
Sandra G. Carr	Secretary 1564 Santa Monica Dunedin, Florida 33528
Sandra G. Carr	Treasurer 1564 Santa Monica Dunedin, Florida 33528

ARTICLE VII

INDEMNIFICATION

7.1 Indemnification. Every Director and every Officer of the Association shall be indemnified by the Association against all expenses and liabilities, including legal fees, reasonably incurred by or imposed upon him in connection with any proceeding or any settlement of any proceeding to which he may be a party or in which he may become involved by reason of his being or having been a Director or Officer of the Association, whether or not he is a Director or Officer at the time such expenses are incurred, except when the Director or Officer is adjudged guilty of willful misfeasance in the performance of his duties; provided that in the event of a settlement the indemnification shall apply only when the Board of Directors approves such settlement and reimbursement as being for the best interests of the Association. The foregoing right of indemnification shall be in addition to and not exclusive of all other rights to which such Director or Officer may be entitled.

ARTICLE VIII

BY-LAWS

8.1 By-Laws. The By-Laws of the Association shall be adopted by the Board of Directors and may be altered, amended or rescinded in the manner provided by the By-Laws.

ARTICLE IX

AMENDMENTS

9.1 Amendments. Subject to the provisions of Section 9.2 of this Article IX, amendments to the Articles of Incorporation shall be proposed and adopted in the following manner:

(a) Notice of the subject matter of a proposed amendment shall be included in the notice of any meeting at which a proposed amendment is considered.

(b) A resolution for the adoption of a proposed amendment may be proposed either by the Board of Directors or by the Members of the Association. Adoption of amendments must be by not less than two-thirds (2/3) of the votes of the entire membership of the Association.

9.2 Limitation on Amendments. No amendment shall make any changes in the qualifications for membership nor the voting rights of Members nor any change in Section 3.3 of Article III, without approval in writing by all Members and the joinder of all record Owners of Mortgages upon the Condominium. No amendment shall be made that is in conflict with the Condominium Act of the State of Florida or the Declaration of Condominium.

ARTICLE X

TERM

10.1 Term. The term of the Association shall be perpetual.

ARTICLE XI

SUBSCRIBERS

11.1 Names and Addresses. The names and addresses of the Subscribers of these Articles of Incorporation are as follows:

<u>NAME</u>	<u>ADDRESS</u>
David G. Tibma	4801 Culbreath Isles Way Tampa, Florida 33609
Allen B. Carr	1564 Santa Monica Dunedin, Florida 33528
Sandra G. Carr	1564 Santa Monica Dunedin, Florida 33528

IN WITNESS WHEREOF, the Subscribers have hereto affixed their signatures this 25 day of OCT, 1973.

David G. Tibma

David G. Tibma

Allen B. Carr

Allen B. Carr

Sandra G. Carr

Sandra G. Carr

UNOFFICIAL COPY

STATE OF FLORIDA
COUNTY OF PINELLAS

I HEREBY CERTIFY that on this date before me, a Notary Public duly authorized to take acknowledgments, personally appeared:

to me known to be the persons described as Subscribers in and who executed the foregoing Articles of Incorporation, and they acknowledged before me that they subscribed to the same.

WITNESS my hand and official seal at Safety Harbor, Florida, this 25 day of OCT, 1973.

Charles E. Trulock

Notary Public, State of Florida at Large
My Commission Expires:

NOTARY PUBLIC STATE OF FLORIDA AT LARGE
MY COMMISSION EXPIRES JULY 5, 1977
BONDED THRU GENERAL INSURANCE UNDERWRITERS



6

KARLEEN F. DE BLAKER, CLERK OF COURT
PINELLAS COUNTY, FLORIDA

N1031456 02-21-2002 09:55:41 BJB
51 AGR-SUNFISH BAY
006255
IH:02069093 BK:11849 SPG:1254 EPG:1257
RECORDING 004 PAGES 1 \$19.50

FILED
02 FEB - 1 11 4 12
SECRETARY OF STATE
TALLAHASSEE, FLORIDA

PREPARED BY AND RETURN TO:
JOSEPH R. CIANFRONE, P.A.
1968 Bayshore Boulevard
Dunedin, Florida 34698

TOTAL: \$19.50
CHECK AMT. TENDERED: \$19.50
CHANGE: \$.00
BY _____ DEPUTY CLERK

02-069093 FEB-21-2002 9:55AM
PINELLAS CO BK 11849 PG 1254

GES 4
COT _____
REC 1950
5219 _____
OG _____
WIT _____
RES _____
MTF _____
P/C _____
REV _____

TOTAL 1950
BAL _____
AMT _____

ARTICLES OF AMENDMENT
TO THE ARTICLES OF INCORPORATION OF
SUNFISH BAY CONDOMINIUM ASSOCIATION, INC.

Pursuant to the provisions of section 617.1006, Florida Statutes, the undersigned corporation adopts the following Articles of Amendment to its Articles of Incorporation.

WE FURTHER CERTIFY THAT the attached amendment to the Articles of Incorporation of Sunfish Bay Condominium Association, Inc., a corporation not-for-profit organized in the laws in the State of Florida, filed on October 30, 1983, was duly adopted by the owners and the number of votes cast for the amendment was sufficient for approval at a meeting held on November 27, 2001.

IN WITNESS WHEREOF, we have affixed our hands this 18 day of January, 2002, at Pinellas County, Florida.

Witnesses:

SUNFISH BAY CONDOMINIUM
ASSOCIATION, INC.

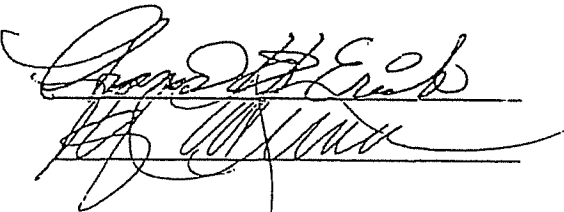

By: Diane Z Weller
President

Attest:
William Willard
Secretary

STATE OF FLORIDA
COUNTY OF PINELLAS

BEFORE ME, the undersigned authority, personally appeared Diane Weller and William Willard, to me

known to be the President and Secretary, respectively, of SUNFISH BAY CONDOMINIUM ASSOCIATION, INC., and they severally acknowledged before me that they freely and voluntarily executed the same as such officers, under authority vested in them by said corporation. They are personally known to me or have produced _____ and _____ (type of identification) as identification and did (did not) take an oath.

WITNESS my hand and official seal in the County and State last aforesaid, this 18th day of January, 2002.

NOTARY PUBLIC

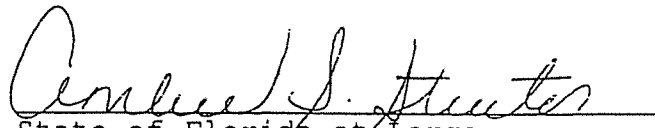
State of Florida at Large

My commission expires:

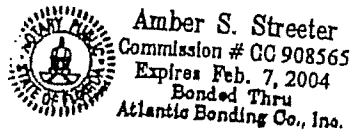

AMENDMENT
TO THE
ARTICLES OF INCORPORATION
OF
SUNFISH BAY CONDOMINIUM ASSOCIATION, INC.

1. ARTICLE V, Section 5.1 of the Articles of Incorporation is amended to read as follows.

5.1 Board of Directors. The affairs of the Association shall be managed by a Board consisting of a number of directors determined by the By-Laws but not less than three (3) Directors, nor more than seven (7) Directors, ~~and in the absence of such determination shall consist of three (3) Director.~~ Directors need not shall be Members of the Association.



Department of State

I certify the attached is a true and correct copy of the Articles of Amendment, filed on February 4, 2002, to Articles of Incorporation for SUNFISH BAY CONDOMINIUM ASSOCIATION, INC., a Florida corporation, as shown by the records of this office.

The document number of this corporation is 727891.

Given under my hand and the
Great Seal of the State of Florida
at Tallahassee, the Capitol, this the
Seventh day of February, 2002



CR2EO22 (1-99)

Katherine Harris

Katherine Harris
Secretary of State

Exhibit C

D. R. 4100 PAGE 732

BY-LAWS
OF
SUNFISH BAY CONDOMINIUM ASSOCIATION, INC.

A corporation not for profit
under the laws of the State of Florida

ARTICLE I

Identification

1.1 Identity. These are the By-Laws of Sunfish Bay Condominium Association, Inc., called Association in these By-Laws, a corporation not for profit under the laws of the State of Florida, the Articles of Incorporation of which were filed in the office of the Secretary of State of Florida. The Association has been organized for the purpose of administering a condominium pursuant to Chapter 711, Florida Statutes, called the Condominium Act in these By-Laws, which Condominium is identified by the name SUNFISH BAY CONDOMINIUM I, and is located upon the lands in Pinellas County, Florida, described in Exhibit "A" attached hereto and for the purpose of administering other condominiums as referred to in said Articles of Incorporation.

1.2 Office. The office of the Association shall be 1111 Bayshore Boulevard, Clearwater, Pinellas County, Florida, or at such other place designated by the Board of Directors.

1.3 Fiscal Year. The fiscal year of the Association shall be the calendar year.

1.4 Seal. The seal of the corporation shall bear the name of the corporation, the word "Florida", the words "Corporation not for profit" and the year of incorporation, an impression of which is as follows:

EXHIBIT "C"

ARTICLE II

Meetings of Members

2.1 Annual Meeting. The annual meeting of the Members shall be held at the office of the corporation, or at such other place designated by the Board of Directors, at 2:00PM, Eastern Standard Time, or at such other time designated by the Board of Directors on the 3rd Tuesday of August of each year for the purpose of electing Directors, except as otherwise provided herein, and transacting any other business authorized to be transacted by the Members; provided, however, if that day is a Saturday, Sunday or a legal holiday, the meeting shall be held at the same hour on the next day that is not a Saturday, Sunday or a legal holiday.

2.2 Special Meetings. Special meetings of the Members shall be held whenever called by the President or Vice President or by a majority of the Board of Directors, and must be called by such Officers upon receipt of a written request from Members entitled to cast one-third (1/3) of the votes of the entire Membership.

2.3 Notice of Meetings. Notice of all meetings of the Members stating the time and place and the objects for which the meeting is called shall be given by the President or Vice President or Secretary unless waived in writing. Such notice shall be in writing to each Member at his address as it appears in the records of the Association and shall be mailed not less than ten (10) days nor more than sixty (60) days prior to the date of the meeting. Proof of such mailing shall be given by the Certificate of the person giving the notice. Notice of meeting may be waived before, at or after meetings.

2.4 Quorum. A quorum at the meetings of the Members shall consist of a majority in interest of Unit Owners of Units in the condominiums referred to in section 2.1 of the Articles of Incorporation, including those represented by proxy. The acts approved by a majority of the votes present at a meeting at which a quorum is present shall constitute the acts of the Members except when approval by a greater number of Members is required by the Declaration of Condominium, the Articles of Incorporation or these By-Laws.

2.5 Voting. In any meeting of members the Owner or Owners of Units shall be entitled to cast one vote for each Unit owned by the Member. If a Unit is owned by one person his right to vote shall be established by the record title to his Unit. If a Unit is owned by more than one person, or is under lease, the person entitled to cast the vote for the Unit shall be designated by a certificate signed by all of the record Owners of the Unit and filed with the Secretary of the Association. If a Unit is owned by a corporation, the person entitled to cast the vote for the Unit shall be designated by a certificate signed by the President or Vice President and attested by the Secretary or Assistant Secretary of the corporation and filed with the Secretary of the Association. Such certificates shall be valid until revoked or until superseded by a subsequent certificate or until a change in the ownership of the unit concerned. A certificate designating the person entitled to cast the vote of a Unit may be revoked by any Owner of a Unit. If such a certificate is not on file, the vote of such Owners shall not be considered in determining the requirement for a quorum nor for any other purpose. The Developer shall be considered a member for voting purposes as provided in Article IV of the Articles of Incorporation.

2.6 Proxies. Votes may be cast in person or by proxy. A proxy may be made by any person entitled to vote and shall be valid only for the particular meeting, or its adjournment, designated in the proxy and must be filed with the Secretary before the appointed time of the meeting or any adjournment of the meeting.

2.7 Adjourned Meetings. If any meeting of the Members cannot be organized because a quorum has not attended, the Members who are present, either in person or by proxy, may adjourn the meeting to a time not later than sixty (60) days from the date set for the original meeting until a quorum is present.

2.8 Order of Business. The order of business at annual meetings of the Members and as far as practical at other meetings of the Members, shall be:

- a. Election of Chairman of the meeting, who shall be the President unless another Chairman is elected by vote of two-thirds (2/3) in interest of Unit owners in the condominiums referred to in Section 2.1 of the Articles of Incorporation.
- b. Calling of the roll and certifying of proxies.
- c. Proof of notice of meeting or waiver of notice.
- d. Reading and disposal of any unapproved minutes.
- e. Reports of Officers.
- f. Reports of Committees.
- g. Election of inspectors of election.
- h. Election of Directors, if applicable.
- i. Unfinished business.
- j. New business.
- k. Adjournment.

2.9 Proviso. Provided, however, that until the Developer of the Condominium has closed the sale of all of the units of the Condominiums referred to in Article II, Section 2.1 of the Articles of Incorporation and all of the contemplated improvements have been completed, or until January 1, 1993, or until the Developer elects to terminate his control of the Condominiums, whichever shall first occur, the proceedings of all meetings of Members of the Association shall have no effect unless approved by the Board of Directors.

ARTICLE III

Directors

3.1 Number. The affairs of the Association shall be managed by a Board of not less than three (3) nor more than eleven (11) Directors, the exact number to be determined at the time of election.

3.2 Election of Directors. The election of Directors shall be conducted in the following manner:

- (a) Election of Directors shall be held at the annual meeting of the Members, except as otherwise provided herein.
- (b) A nominating committee of five (5) members shall be appointed by the Board of Directors not less than thirty (30) days prior to the annual meeting of the Members. The committee shall nominate one (1) person for each Director then serving. Nominations for additional

directorships created at the meeting shall be made from the floor, and other nominations may be made from the floor.

(c) The election shall be by a ballot (unless dispensed with by unanimous consent) and by a plurality of the votes cast, each person voting being entitled to cast his votes for each of as many nominees as there are vacancies to be filled. There shall be no cumulative voting.

(d) Except as to vacancies provided by removal of Directors by Members, vacancies in the Board of Directors occurring between annual meetings of Members shall be filled by the remaining Directors.

(e) Any Director may be removed by concurrence of two-thirds (2/3) of the votes of the entire Membership at a special meeting of the Members called for that purpose. The vacancy in the Board of Directors so created shall be filled by the Members of the Association at the same meeting.

(f) Provided, however, and notwithstanding anything hereinabove or below, that until the Developer of the Condominium has closed the sales of all of the Units of the Condominium and of all the Units in other condominiums described in Section 2.1 (Article II) of the Articles of Incorporation and all of the contemplated improvements therein have been completed, or until January 1, 1993, or until the Developer elects to terminate his control of the Condominium(s), whichever shall first occur, the first Directors of the Association shall serve and the first election of Directors shall not take place, and in the event of vacancies the remaining Directors shall fill the vacancies and if there are no remaining Directors the vacancies shall be filled by the Developer.

3.3 Term. Except as otherwise provided herein, the term of each Director's service shall extend until the next annual meeting of the Members and, subsequently, until his successor is duly elected and qualified or until he is removed in the manner elsewhere provided.

3.4 Organization Meeting. The organization meeting of a newly-elected Board of Directors shall be held within ten (10) days of their election at such time and place as shall be fixed by the Directors at the meeting at which they were elected, and no further notice of the organization meeting shall be necessary.

3.5 Regular Meetings. Regular meetings of the Board of Directors may be held at such time and place as shall be determined, from time to time, by a majority of the Directors. Notice of regular meetings shall be given to each Director, personally or by mail, telephone or telegraph, at least three (3) days prior to the day named for such meeting.

3.6 Special Meetings. Special meetings of the Directors may be called by the President and must be called by the Secretary at the written request of one-third (1/3) of the Directors. Not less than three (3) days notice of the meeting shall be given personally or by mail, telephone or telegraph, which notice shall state the time, place and purpose of the meeting.

3.7 Waiver of Notice. Any Director may waive notice of a meeting before or after the meeting and such waiver shall be deemed equivalent to the giving of notice.

3.8 Quorum. A quorum at Directors' meetings shall consist of a majority of the entire Board of Directors. The acts approved by a majority of those present at a meeting at which a quorum is present shall constitute the acts of the Board of Directors, except when approval by a greater number of Directors is required by the Declaration of Condominium, the Articles of Incorporation or by these By-Laws.

3.9 Adjourned Meetings. If at any meeting of the Board of Directors there be less than a quorum present, the majority of those present may adjourn the meeting from time to time, until a quorum is present. At any adjourned meeting any business that might have been transacted at the meeting as originally called may be transacted without further notice.

3.10 Joinder in Meeting by Approval of Minutes. The joinder of a Director in the action of a meeting by signing and concurring in the minutes of that meeting shall constitute the presence of such Director for the purpose of determining a quorum.

3.11 Presiding Officer. The Presiding Officer at Directors' meetings shall be the Chairman of the Board, if such an Officer has been elected; and, if none, the President shall preside. In the absence of the Presiding Officer the Directors present shall designate one of their number to preside.

3.12 Order of Business. The order of business at Directors' meetings shall be:

- a. Call of roll.
- b. Proof of due notice of meeting.
- c. Reading and disposal of any unapproved minutes.
- d. Reports of Officers and Committees.
- e. Election of Officers, if applicable.
- f. Unfinished business.
- g. New business.
- h. Adjournment.

3.13 Directors' Fees. Directors' fees, if any, shall be determined by the Members.

ARTICLE IV

Powers and Duties of the Board of Directors

4.1 Powers and Duties of the Board of Directors. All of the powers and duties of the Association existing under the Condominium Act, the Declaration of Condominium, the Articles of Incorporation and these By-Laws shall be exercised exclusively by the Board of Directors, its agents, contractors, or employees, subject only to approval by Unit Owners when such is specifically required.

ARTICLE V

Officers

5.1 Executive Officers. The executive officers of the Association shall be a President, who shall be a Director, a Vice President, who shall be a Director, a Treasurer, a Secretary and an Assistant Secretary, all of whom shall be elected annually by the Board of Directors and who may be preemptorily removed by vote of the Directors at any meeting. Any person may hold two or more offices, except

that the President shall not be also the Secretary or an Assistant Secretary. The Board of Directors from time to time shall elect such other Officers and designate their powers and duties as the Board shall find to be required to manage the affairs of the Association.

5.2 President. The President shall be the Chief Executive Officer of the Association. He shall have all of the powers and duties usually vested in the office of President of an Association, including but not limited to the power to appoint committees from among the Members from time to time, as he in his discretion may determine appropriate, to assist in the conduct of the affairs of the Association.

5.3 Vice President. The Vice President in the absence or disability of the President shall exercise the powers and perform the duties of the President. He also shall assist the President generally and exercise such other powers and perform such other duties as shall be prescribed by the Directors.

5.4 Secretary. The Secretary shall keep the minutes of all proceedings of the Directors and the Members. He shall attend to the giving and serving of all notices to the Members and Directors and other notices required by law. He shall have custody of the seal of the Association and affix it to instruments requiring a seal when duly signed. He shall keep the records of the Association, except those of the Treasurer, and shall perform all other duties incident to the office of Secretary of an Association and as may be required by the Directors or the President. The Assistant Secretary shall perform the duties of the Secretary when the Secretary is absent.

5.5 Treasurer. The Treasurer shall have custody of all property of the Association, including funds, securities and evidences of indebtedness. He shall keep the books of the Association in accordance with good accounting practices; and he shall perform all other duties incident to the office of Treasurer.

5.6 Compensation. The compensation of all Officers and employees of the Association shall be fixed by the Directors. The provisions that Directors' fees shall be determined by Members shall not preclude the Board of Directors from employing a Director as an employee of the Association, nor preclude the contracting with a Director for the management of the Condominium.

ARTICLE VI

Fiscal Management

6.1 Fiscal Management. The provisions for fiscal management of the Association set forth in the Declaration of Condominium and Articles of Incorporation shall be supplemented by the provisions of Section 6.2 through 6.9 of this Article VI.

6.2 Accounts. The receipts and expenditures of the Association shall be credited and charged to accounts under the following classifications as shall be appropriate, all of which expenditures shall be common expenses:

- (a) Current expense for the operation and maintenance of the condominiums as provided by their respective Declarations of Condominium and by the Articles of Incorporation and these By-Laws of the Association, which shall include all receipts and expenditures within the year for which the budget is made, including a reasonable allowance for contingencies and working funds, except expenditures

chargeable to reserves or to additional improvements. The balance in this fund at the end of each year shall be applied to reduce the assessments for current expense for the succeeding year.

(b) Reserve for deferred maintenance, which shall include funds for maintaining items that occur less frequently than annually.

(c) Reserve for replacement, which shall include funds for repair or replacement required because of damage, depreciation or obsolescence.

(d) Betterments, which shall include the funds to be used for capital expenditures for additional improvements or additional personal property that will be part of the common elements.

6.3 Budget. The Board of Directors shall adopt a budget for each calendar year (and, if the first year of operation is begun after January 1, then for that partial year) which shall include the estimated funds required to defray common expense, and any other expenses of the Association, to operate and maintain the condominiums as provided by their respective Declarations of Condominium and by the Articles of Incorporation and these By-Laws of the Association, and to provide and maintain funds for the foregoing accounts and reserves according to good accounting practices as follows:

(a) Current expenses as described above.

(b) Reserve for deferred maintenance.

(c) Reserve for replacement.

(d) Betterments, which shall include the funds to be used for capital expenditures for additional improvements or additional personal property that will be part of the common elements; provided, however, that in the expenditures of this fund no sum in excess of \$ 5000.00 shall be expended for a single item or purpose without approval of a majority of the Members of the Association.

(e) Copies of the budget and proposed assessments shall be transmitted to each Member on or before December 1 preceding the year for which the budget is made, except for the first year of operation, if begun after January 1, in which year such transmittal shall be as the Board shall direct. If the budget is amended subsequently, a copy of the amended budget shall be furnished to each Member.

6.4 Assessments. Assessments against the Unit Owners (subject to any exceptions specified in the Declaration) for their shares of the common expenses and items of the budget shall be made for the calendar year annually in advance on or before December 20 preceding the year for which the assessments are made, except that assessments for the first year of operation, if begun after January 1, shall be made at such time as the Board shall direct. Such assessments shall be due in equal, monthly installments on the first day of each month of the year for which the assessments are made. If an annual assessment is not made as required, assessments shall be presumed to have been made in the amount of the last prior assessment and monthly installments on such assessment shall be due on each installment payment date until changed by an amended assessment. In the event the annual assessment proves to be insufficient, the budget and assessments may

be amended at any time by the Board of Directors. The unpaid assessments for the remaining portion of the calendar year for which the amended assessment is made shall be divided equally among the remaining months of the year and shall be due on the first day of each remaining month of the year. Assessments shall be determined by the Board of Directors of the Association. In amplification, but not in limitation of the foregoing, assessments shall be made for servicing, maintenance, repair and replacement by the Association of all properties for which the Association is so responsible as provided in the Declaration, Articles of Incorporation, and these By-Laws, including exterior surfaces of Units and for such other purposes as may be specified in those documents, or any of them.

6.5 Acceleration of assessment installments upon default. If a Unit Owner shall be in default in the payment of an installment upon an assessment, the Board of Directors may accelerate the remaining installments of the assessment upon notice to the Unit Owner, and then the unpaid balance of the assessment shall come due upon the date stated in the notice, but not less than ten (10) days after delivery of the notice to the Unit Owner, or not less than twenty (20) days after the mailing of such notice to him by registered or certified mail, whichever shall first occur.

6.6 Assessments for emergencies. Assessments for common expenses of emergencies that cannot be paid from the annual assessments for common expenses shall be made only after notice of the need for such is given to the Members. After such notice and upon approval in writing by persons entitled to cast more than one-half (1/2) of the votes of the Members, the assessment shall become effective, and it shall be due after thirty (30) days notice in such manner as the Board of Directors of the Association may require in the notice of assessment.

6.7 Depository. The depository of the Association shall be in such bank or banks as shall be designated from time to time by the Directors and in which the moneys of the Association shall be deposited. Withdrawal of moneys from such accounts shall be only by checks signed by such persons as are authorized by the Directors.

6.8 Audit. An audit of the accounts of the Association shall be made annually, and a copy of the audit report shall be furnished to each Member not later than April 1 of the year following the year for which the audit is made.

ARTICLE VII

Parliamentary Rules

7.1 Parliamentary Rules. Roberts Rules of Order (latest edition) shall govern the conduct of Association meetings when not in conflict with the Declaration of Condominium, Articles of Incorporation or these By-Laws.

ARTICLE VIII

Amendments

8.1 Amendments. Amendments to the By-Laws may be made in accordance with the procedure hereinafter provided, so long as not inconsistent with the Articles of Incorporation or the Declaration of Condominium.

8.2 Notice. Notice of the subject matter of a proposed amendment shall be included in the notice of any meeting at which a proposed amendment is considered.

8.3 Resolution. A resolution adopting a proposed amendment may be proposed either by the Board of Directors of the Association or by the members of the Association.

8.4 Adoption of Resolution. In order for a Resolution adopting a proposed amendment to become effective it must be approved as hereinafter set out. Directors and members not present in person or by proxy at the meeting considering the amendment may express their approval in writing, provided such approval is on file with the Secretary prior to the meeting.

(a) During the first five (5) years from date of recording of these By-Laws said Resolution must be by affirmative vote of the Owners of Fifty-One percent (51%) of the Units together with the written consent of the Developer, its successors or assigns; or,

(b) After the expiration of five (5) years from date of recording of these By-Laws said Resolution must be by affirmative vote of the owners of two-thirds (2/3) of the Units without the consent of the Developer; but, and notwithstanding the foregoing,

(c) Until the first election of Directors, only by all of the Directors, with the written consent of the Developer.

8.5 Proviso. Provided, however, that no amendment shall unreasonably discriminate against any Unit Owner or against any Unit or class or group of Units unless the Unit Owners so affected shall consent. No amendment shall be made that is in conflict with the Articles of Incorporation or the Declaration of Condominium.

8.6 Execution and Recording. A copy of each amendment shall be attached to a certificate certifying that the amendment was duly adopted as an amendment of the Declaration of Condominium and By-Laws, which certificate shall be executed by the officers of the Association with the formalities of a deed. The amendment shall be effective when such certificate and copy of the amendment are recorded in the Public Records of Pinellas County, Florida.

The foregoing were adopted as the By-Laws of SUNFISH BAY CONDOMINIUM ASSOCIATION, INC., a corporation not for profit under the laws of the State of Florida, at the first meeting of the Board of Directors on November 1, 1973.

Sandra J. Carr
Secretary

Approved:

David B. Palma
President